

Noise simulator

INS-4020 / 4040

Feature

- Reduce the complicated wiring with the floating generation circuit
- Easy setting either to Common mode or Normal mode with short plug
- Easy wiring with built-in 50Ω termination
- Simple setting of the repetitive cycles (VARIABLE, LINE PHASE) only on the main unit
- New function that enables to sweep the repetitive cycles arbitrarily is added
- Direct connection of AC plug on EUT can be available with optional outlet panel
- Various tests methods can be realized with optional probes and coupling adaptors
- 3-phase 5 lines of EUT can be tested with addition of optional injection unit



INS-4020/4040

Specification

Parameter	INS-4020	INS-4040	
Square wave	Pulse width	50, 100, 200, 250, 400ns±10% combination thereof, maximum width 1μs, or 10ns±3ns (the shortest connection)	
	Output voltage	0.01~2.00kV±10% (0.0.4kV for <0.1kV) 10V step	0.01~4.00kV±10% (0.0.4kV for <0.1kV) 10V step
	Polarity	Positive and negative	
	Rise-up time	≤1ns	
	Output impedance	50Ω system (53.5Ω)	
Pulse repetition mode	VARIABLE	10ms~999ms±10% (1ms step) Sweep available	16ms~999ms±10% (1ms step) Sweep available
	MANUAL	One shot along LINE PHASE setting, Single output without line input	
	LINE PHASE	50Hz / 60Hz Injection Phase angle 0~360° ±10 DEG (1 DEG step) Sweep available	
	EXT TRIG	●EXT TRIG mode Operation cycle : ≥10ms Pulse width : ≥1ms Input level : TTL / Open collector negative logic	●EXT TRIB mode Operation cycle : ≥16ms Pulse width : ≥1ms Input level : TTL / Open collector negative logic
Memory capacity	5 tests		
EUT power capacity	AC240V / DC60V 16A		
Power supply / Power consumption	AC100~240V 50Hz / 60Hz / 140VA		
Operating temperature / humidity range	15~35°C / 25~75%		
Dimension / Mass	(W) 430 X (H) 249 X (D) 420mm / Approx. 19kg		
High voltage coaxial connector	NMHV Noiseken custom		

Accessory

Item	Model number	Q'ty
Pulse width setting cable 30m	02-00013A	6 pcs.
SG setting short plug	02-00106A	1 pc.
Outlet panel	18-00061B	1 pc.
Power supply cable		1 pc.
Instruction manual		1 volume

Front Panel

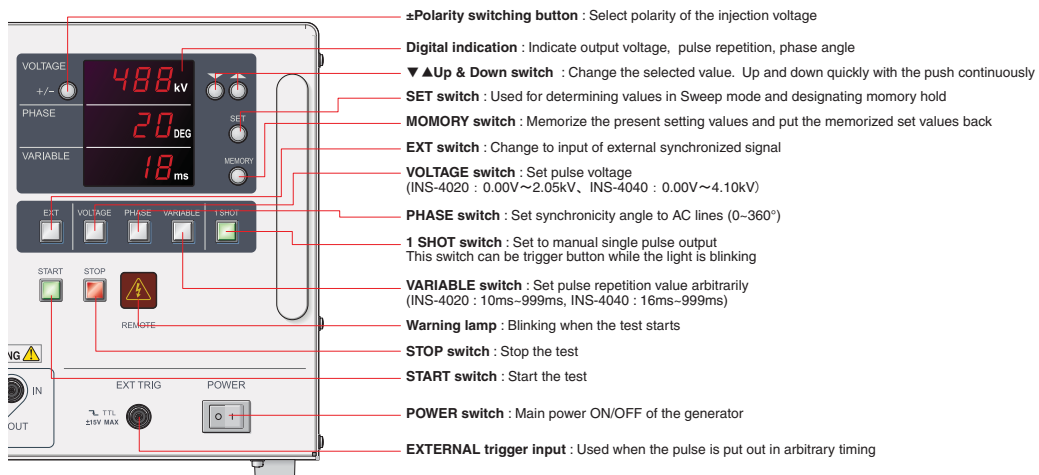

Noise simulator

INS-AX2 Series

Feature

- Realize automation and efficiency in the test
- Rich variety is prepared along output voltage and EUT power capacity
- Simple and easy setting of the pulse widths with preset of 8 kinds pulse widths
- Simple and easy setting of the test parameters with PC remote control whose software is standard attached
- Programming on the control panel of the main unit is also available (The memory is limited)
- Enable to switch Common mode / Normal mode and injection angle in the main unit
- Enable to correct the pulse voltage indication by the termination impedance along line injection or clamp use
- EUT FAIL INPUT terminal built-in. Enable to control the test stop when EUT is malfunctioned during the automated test
- Direct connection of AC plug on EUT can be available with optional outlet panel
- Various tests methods can be realized with optional probes and coupling adaptors



INS-AX2

Specification

Parameter	Specification	Note	
Output voltage	INS-AX2-220 / 250 : 0.01~2.00kV \pm 10% (\pm 0.04kV for <0.1kV) INS-AX2-420 / 450 : 0.01~4.00kV \pm 10% (\pm 0.04kV for <0.1kV)		
Polarity	Positive and negative		
Pulse	Pulse width	50, 100, 200, 400, 500, 800, 1000ns \pm 10% 10ns \pm 3ns	Square wave
	Rise-up time	1ns \pm 30% (220T / 420T / 250T / 250TH / 450T / 250TH)	Triangular wave half-value
		\leq 1ns	Square wave
		\leq 40ns (220T / 420T / 250T / 250TH / 450T / 250TH)	Triangular wave
	Polarity	Positive and negative	
	Output impedance	50 Ω system (53.5 Ω)	
Pulse repetition mode	LINE PHASE	Injection angle 0~360 $^{\circ}$ \pm 10% EUT power supply : Operatable at AC \geq 90V 50 / 60Hz \pm 10%	
	VARIABLE	10ms~999ms \pm 10% (220 / 250) 16ms~999ms \pm 10% (420 / 450)	
	1 SHOT TRIG	Single output whenever pushing 1 SHOT switch Synchronized output with set phase angle in PHSE mode	
EUT power capacity	Single phase AC240V / DC65V, 20A (220 / 420) 3-phase AC500V / DC250V, 50A (250H / 250TH / 450H / 450TH) AC50 / 60Hz \pm 10%		
Power supply / Power consumption	AC100~240V \pm 10% 50 / 60Hz \pm 10% / 110VA		
Operating temperature / humidity range	15~35 $^{\circ}$ C / 25~75%		
Dimension	(W) 430 X (H) 350 X (D) 470mm (Projection excluded)		
Mass	INS-AX2-220 / 420 : Approx. 30kg INS-AX2-250 / 450 : Approx. 40kg		
High voltage coaxial connector	NMHV	Noiseken custom	

Series Classification

Model	Max. output voltage	EUT power capacity	Note
INS-AX2-220	2kV	Single phase AC240V/DC65V 20A	
INS-AX2-200T	2kV	Single phase AC240V/DC65V 20A	Triangular wave
INS-AX2-250	2kV	Single/3-phase 4 lines AC300V/DC65V 50A	INS-AX2-250
INS-AX2-250T	2kV	Single/3-phase 4 lines AC300V/DC65V 50A	Triangular wave
INS-AX2-250H	2kV	Single/3-phase 4 lines AC500V/DC250V 50A	INS-AX2-250H
INS-AX2-250TH	2kV	Single/3-phase 4 lines AC500V/DC250V 50A	Triangular wave
INS-AX2-420	4kV	Single phase AC240V/DC65V 20A	
INS-AX2-420T	4kV	Single phase AC240V/DC65V 20A	Triangular wave
INS-AX2-450	4kV	Single/3-phase 4 lines AC300V/DC65V 50A	INS-AX2-450
INS-AX2-450H	4kV	Single/3-phase 4 lines AC500V/DC250V 50A	INS-AX2-450H
INS-AX2-450TH	4kV	Single/3-phase 4 lines AC500V/DC250V 50A	Triangular wave

Accessory

Item	Q'ty	Note
Outlet panel (18-00067A) (for single phase terminal)	1 pc.	AC240V/DC65V 20A Max (220/220T/420/420T)
Outlet panel (18-00068A) (for 3-phase terminal)	1 pc.	AC300V/DC65V 50A Max (250/250T/450/450T)
Outlet panel (18-00074A) (for 3-phase terminal)	1 pc.	AC240V/DC65V 20A Max (250H/250TH/450H/450TH)
Power supply cable	1 pc.	
Instruction manual for main unit	Each. 1	
Instruction manual for software	volume	
Software	1 pc.	
Optical conversion adaptor	1 pc.	
AC adaptor for optical conversion adaptor	1 pc.	
Optical cable (5m)	1 pc.	
D-sub conversion connector (RS23C)	1 pc.	
Bag for accessories	1 pc.	

INS-AX2-Series

Front Panel / Rear Panel

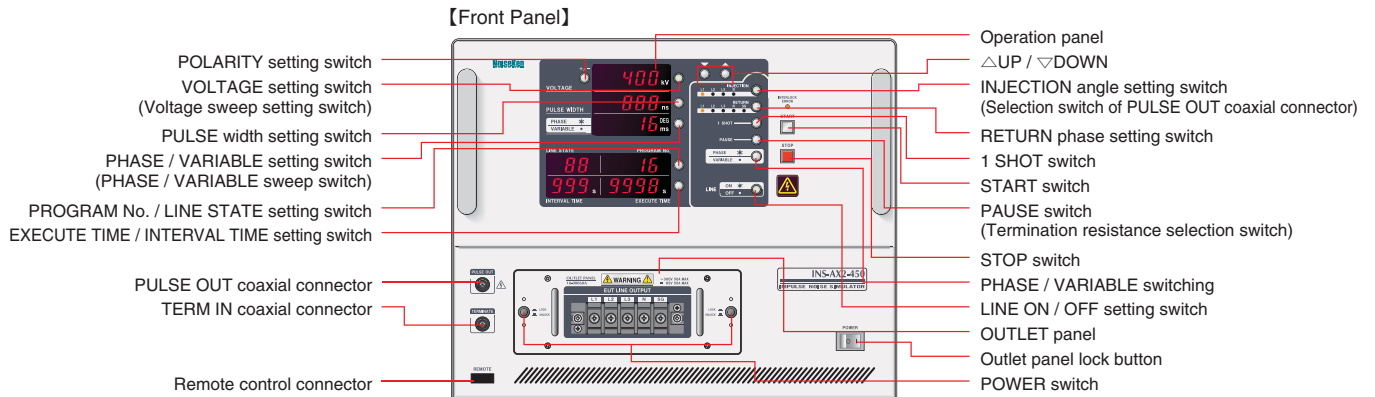

INS-AX2-420/220

【Rear Panel】

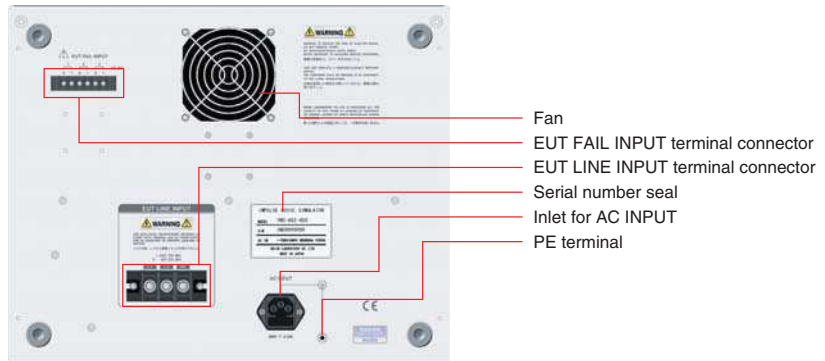

INS-AX2-420/220

Software (Standard accessory)

Software to work, control and assist in the operation of INS-AX2 series more versatility Automated operations in the test conditions setting (Output voltage, injection phase, voltage sweep, etc.) as well as the combined test of those conditions are enabled.

- PC remote control for INS-AX2 is enabled with the standard software
- Realize to make unrestricted test conditions as well as the test with its test conditions programming function
- Enable to conduct the identical test conditions whenever requested with its test conditions memorizing function same test By saving functioning
- Enable to make the test report (Preview and printing possible) with its reporting function

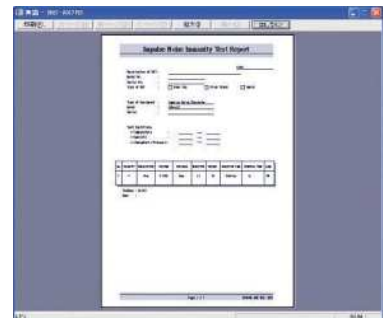
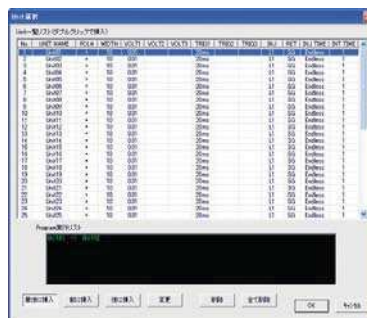
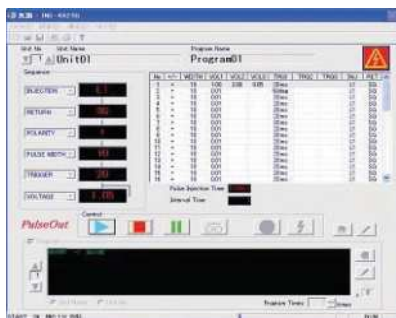

Attenuator for checking waveform **MODEL : AT-810**

Attenuator developed for observing the high voltage pulse

Parameter	Specification
Attenuation quantity	40dB at DC~500MHz (Tolerance 40dB~44dB *) *1/100±5% in DC
Input Pulse peak voltage	Max. 4000V
Square wave Pulse width	50ns~1000ns
Pulse width repetitive frequency	Max. 60Hz at 4000V output Max. 100Hz at 2000V
Input impedance	50Ω
Output impedance	50Ω 50Ω termination is necessary in case of using high input impedance oscilloscope
Mass	Approx. 550g

Coupling Adaptor **MODEL : CA-803A (Magnetic field coupling)**

Enable for testing characteristics against the noise only with clamping communication cables of electronics equipments in combination with INS series.

- Enable to inject the noise without cutting signal, DC, AC, GND, etc.
- Enable to test the noise resistibility of electronics equipments separated individually.
- Enable to clamp bundle of signal lines whose maximum diameter is 15mm
- Termination resistance built-in.

Parameter	Specification
Input voltage	2000V Max
Input pulse width	50~1000ns
Coupling ratio	1/20±10% of input voltage
Storage temperature range	-5~55°C
Dimension / Mass	(W) 160 X (H) 60 X (D) 35mm / Approx 400g

Coupling Adaptor **MODEL : CA-805B (Capacitive coupling)**

Enable for testing characteristics against the noise only with clamping communication cables of electronics equipments in combination with INS series.

- Enable to inject the noise without cutting signal, DC, AC, GND, etc.
- Enable to test the noise resistibility of electronics equipments separated individually.
- Realize to test the noise resistibility effectively since the injection can be directly to signal lines.
- Enable to clamp bundle of signal lines whose maximum diameter is 26mm

Parameter	Specification
Input voltage	4000V Max
Input pulse width	50~1000ns
Dimension / Mass	(W) 350 X (H) 120 X (D) 130mm / Approx 3kg
Storage temperature range	-5~55°C
Inside diameter of the clamp	26mm

Coupling Adaptor **MODEL : 15-00007A (CA-806 / Magnetic field coupling)**

Enable for testing characteristics against the noise only with clamping communication cables of electronics equipments in combination with INS series.

- Enable to inject the noise without cutting signal, DC, AC, GND, etc.
- Enable to test the noise resistibility of electronics equipments separated individually.
- Termination resistance built-in.

Parameter	Specification
Structure	Magnetic field coupling noise injection clamp
Input voltage	2000V Max.
Input pulse width	50~1000ns
Coupling ratio	1/10±10% of input voltage
Termination resistance	50Ω system built-in
Max. diameter of ground cable	27mm
Dimension / Mass	(W) 89 X (H) 64 X (D) 120mm / Approx 1000g

Option

Coupling Probe **MODEL : 95242-1**



Produced by ETS LINDGREN

Enable for testing characteristics against the noise only with clamping communication cables of electronics equipments in combination with INS series.

* Conversion cable (Model : 02-00075A) is necessary for connecting this probe with INS series.

Parameter	Specification
Frequency range	10MHz-400MHz
Max. input power	100W
Max. input current	25A

Triangular Wave Generation Unit **MODEL : 02-00099A**



An unit to change the output waveform from square waveform to triangular waveform by attachment to the output of INS-4020 / 4040 without any modification

Parameter	Specification
Coaxial cable	NMHV
Output pulse	Triangular wave
Peak value	±4kV (Terminated with 50Ω system termination resistance in INS)
Pulse width (Half value)	1μs±30%
Rise-up time	≤40ns
Polarity	Positive and negative
Dimension	80 X 80 X 150mm (Projection excluded)
Mass	0.39kg

Circuit Breaker Box **MODEL : 18-000072A (20A) / 18-00073A (50A)**



Parameter (18-00072A)	Specification
Rated operating voltage	AC250V 50 / 60Hz DC65V
Standard rated current	20A
Switching life	≥10000 times (Rated switching 6000 times, switching without load 4000 times, switching frequency 6 times/min)
Operating temperature / humidity range	15-35°C 25-75% (without dew)
Dimension / Mass	(W) 180x(H)92x(D) 100mm (Projection excluded) /0.75 kg

Parameter (18-00073A)	Specification
Rated operating voltage	AC20V / 415V 3-phase 4 lines Y-connection 50 / 60Hz AC240V between LINE - Neutral pole (N pole) AC415V between LINE - LINE
Standard rated current	50A
Switching life	≥10000 times (Rated switching 6000 times, switching without load 4000 times, switching frequency 6 times/min)
Neutral pole (N pole)	No trip alone Neither open-circuit before other poles nor closed-circuit after the other poles
Operating temperature / humidity range	15-35°C 25-75% (without dew)
Dimension / Mass	(W) 180x(H)92x(D) 120mm (Projection excluded) /12 kg

Noise Canceller Transformer

In order to secure the safety in the operation when INS series is used for the test to AC power lines of EUT, a isolation transformer should be inserted and connected in between the power source and INS series.

It is not anything special but must be compatible with the spec and performance of EUT. If it is difficult to be prepared locally, please contact us so we can quote it.

Outlet Panel **MODEL : 18-00059C / 60B**



Outlet panel to be available for different types of connectors in line output of INS-4020 / 4040

Model : 18-00059C	For Japan / USA AC125V 20A Max
Model : 18-00060B	For CEE type AC240V 16A Max

● INS-4020 / INS-4040

Outlet Panel MODEL : 18-00069A / 71A

69A

Outlet panel to be available for different types of connectors in line output of INS-AX2 series



71A

Model : 18-00069A	For Japan / USA AC125V 20A Max
Model : 18-00071A	Multi-connectors type AC240V 15A Max

●INS-AX2-Series

Injection Unit MODEL : IJ-4050

Unit to enable the noise injection for power supply lines of EUT up to 3-phase 5 lines (L1, L2, L3, N, PE) in combination with main units of INS series. Setting for Normal mode and Common mode is simple and easy only with change of the connectors configurations
In case of the combination with INS-4020 / 4040, test synchronized with EUT lines can be conducted.

Parameter	Specification
Input impulse voltage	Max. 8kV without 50Ω termination Max. 4kV with 50Ω termination
EUT power capacity	3-phase 5 lines (L1, L2, L3, N, PE) AC415V 50A (Unavailable for DC) AC415V between L1-L2, L2-L3, L3-L1 AC240V between L1, L2, L3 – N
Change of injection angle	With connectors configurations L1, L2, L3, N, PE
Coupling mode	Normal / Common (Setting with short plug connection)
Line synchronization detection	Detects between L1 – L2 add put out the synchronizatoion signal from SYNC OUT terminal
EUT line protection circuit	Detects current in L1, L2 and L3 lines and breaks L1, L2, L3 and N lines
EUT line input terminal	Horizontal conductor connection
EUT line output terminal	Exclusive contact for φ6
Attenuation characteristics on coupling	≤-10db 10kHz-10Hz without load
Residual voltage at input	≤450V Residual voltage without load when 4000V impulse is injected with 50Ω termination
Termination resistance	Nothing (Termination resistance in the main unit is applied)
Power supply	AC100V-240V±10% 50 / 60Hz 20VA Max
Operating temperature / humidity range	15-35°C 25-75%
Dimension / Mass	(W) 430x(H)199x (D) 535mm (Projection excluded Approx 25kg)

●INS-4020 INS-4040

Injection Unit MODEL : IJ-5100

Unit to enable the noise injection for power supply lines of EUT up to 3-phase 5 lines (L1, L2, L3, N, PE) in combination with main units of INS series.
In combination with INS series, test synchronized with EUT lines can be conducted.

Parameter	Specification
Max. pulse injection voltage	4000V ((with 50Ω termination)
EUT lines	3-phase 5 lines (L1, L2, L3, N, PE)
Max. voltage of EUT lines	AC480V
Max. current of EUT lines	100A
Line synchronization output	1/2 of EUT input voltage
Pass characteristics	≤-10dB in 10kHz-1GHz
CDN power supply	AC100-240V±10% 50 / 60Hz
Dimension / Mass	(W) 488x(H)520x (D) 825mm (Projection excluded Approx 115kg)

●INS-4020 INS-4040

Optical USB Module MODEL : 07-00022A

Interface adaptor for remote controlling the generator main unit with PC
USB – optical conversion : Optical fiber cable 5m attached

●INS-AX2-Series

SG cable MODEL : 05-00103A

Braided wire cable to connect between SG terminal of the main unit and the ground reference plane.
Length : 0.1m

Option

EMS Probe Kit **MODEL : H2-B**



Probes set to enable the noise injection onto PCB patterns, flat cables, etc. in the connection with the generator. The probes can be selected per electric fields or magnetic fields and the irradiation in the near field can be performed.

- Arbitrary noise injection to where it is desired on PCB or harness.
- Enable to detect point which the noise resistibility is weak per electric field and magnetic field with the probes differentiation.
- Varied probes are ready. Each 3 pieces of different figure and size are contained for electric field and magnetic field.
- Enable to pinpoint where the noise resistibility is weak since the injection can be done in such small range several mm.
- Enable to detect point where the noise resistibility is weak in particular frequency in combination with a signal generator
- Available to equip with noise simulator already on hand.

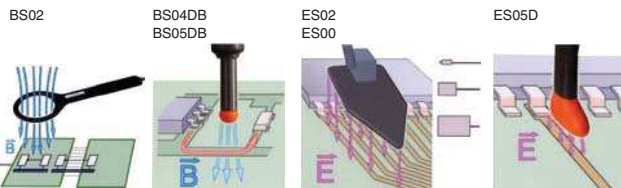

In use of INS : Voltage $\leq 1kV$, Pulse width $\leq 50ns$

Noise Simulator

Output spectrum in input of INS waveform

Input voltage : 1000V

Rise-up time : 1ns

Pulse width ; 10ns

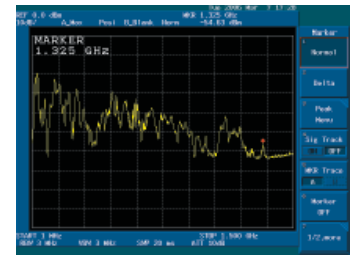
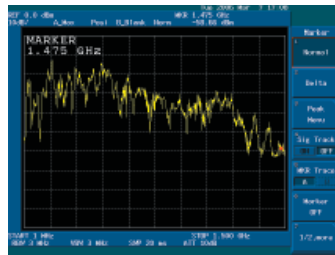
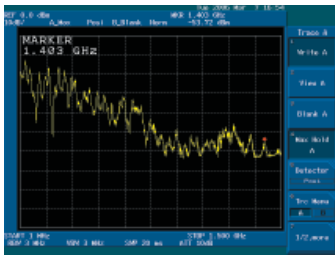

- ①BS05DB
- ②ES02
- ③ES00
- ④ES05D
- ⑤BS02

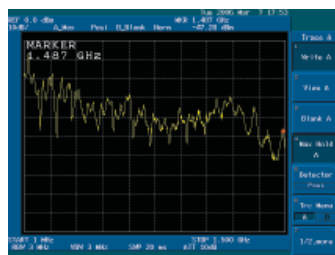
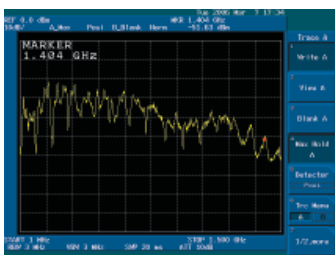

Noise Injection Probe **MODEL : 01-00034A**



- Enable to test the noise resistibility in a board level since the direct injection to LSI pin by pin is possible
- Possible for the noise injection up to 500V utilizing noise simulator on hand.
- Possible to exchange the coupling capacitor (Option)

[Option]

Coupling capacitors: 06-00039A : 220pF 06-00040A : 330pF 06-00041A : 3pF 06-00042A : 500pF
 * 01-00034A. does not contain the coupling capacitors

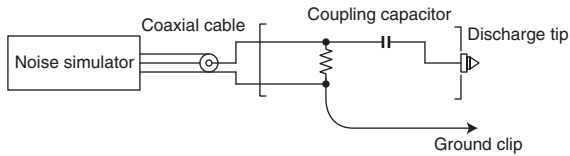

Radiation Probes **MODEL : 01-00006A / 7A / 8A / 9A / 10A**



Probes to irradiate the radiation noise to wiring on PCB of electronics equipments so that point where the radiation noise resistibility is weak can be detected.

Parameter	Specification
Input voltage	4000V Max
Input pulse width	50ns~1μs
Loop diameter	01-00006A : φ 50mm, 01-00007A : φ 75mm, 01-00008A : φ 100mm 01-00009A : φ 150mm, 01-00010A : φ 200mm
Cable length	Approx. 2m
Mass Approx.	180g~220g
Applicable connector	NMHV type

Noise Simulator

Application Example of Probes

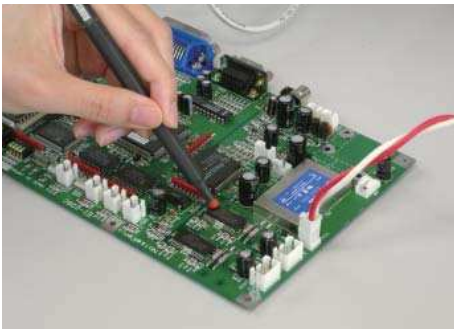

H2-B

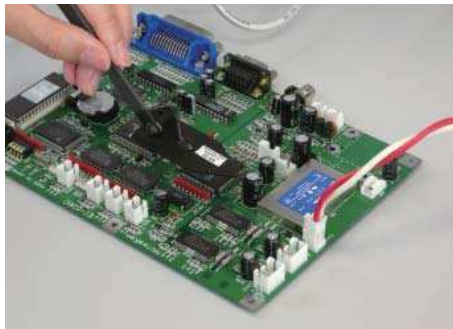

H2-B

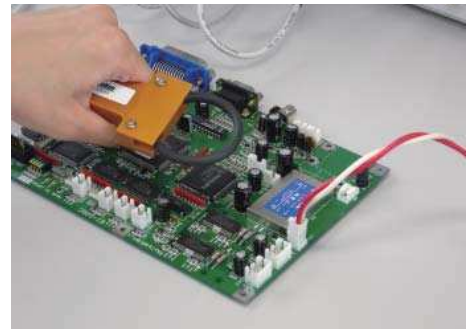

Radiation probe

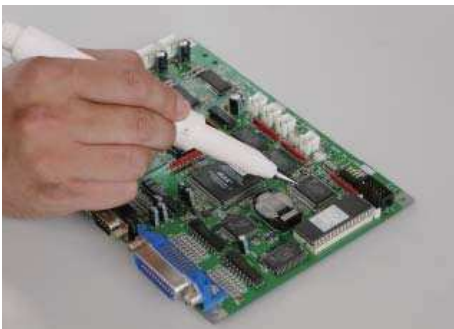

Noise injection probe

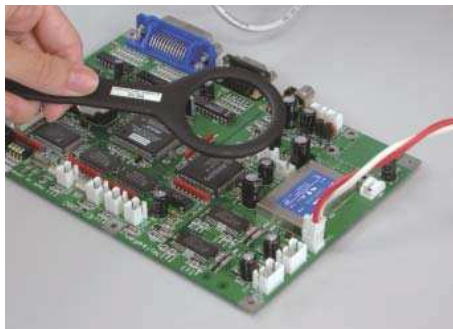

H2-B



H2-B

INS Test Setup Summary

INS Test Method

Method or test to power supply lines

- ① Connect power supply line for EUT to EUT LINE INPUT on the simulator main unit (hereafter called as main unit) through an isolation transformer
- ② Lay a ground plane and insulation sheet under main unit and EUT, and ground them for securing
- ③ Connect power supply cable of EUT to main unit (Fold and bind the cable so it can be short in case the length is long)
- ④ Connect short adaptor to SG. Connect SG terminal of main unit and FG terminal (In case it is there) of EUT to ground plane with low impedance braided wire shortly and securely
- ⑤ Connect 50Ω TERM OUT connector to connector of phase (L1 or L2, PE if necessary) the noise is intended to be injected with coaxial cable

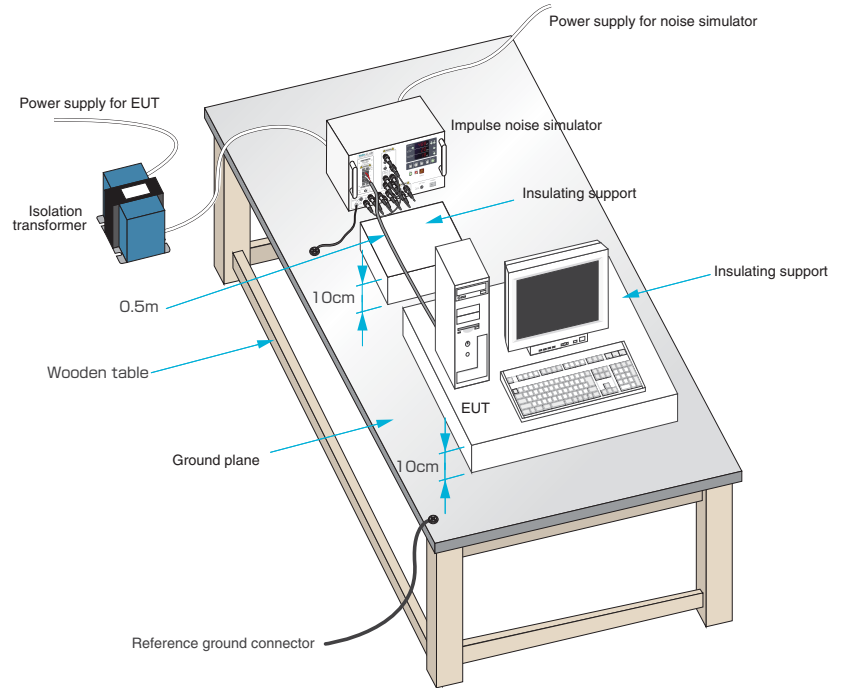

Method or test to interconnection lines

- ① Lay a ground plane and insulation sheet under main unit and EUT, and ground them for securing
- ② Open coupling adaptor CA-805B (Option) and clamp interface cable with the adaptor. Connect connector of the adaptor to PULSE OUT of main unit. Connect the one another connector of the adaptor to 50Ω TERM IN of main unit. In case for coupling adaptor CA-803A (Option), connect PULSE OUT of main unit and connector of the adaptor
- ③ Connect power supply cable of EUT to arbitrary power source since no high voltage pulse is injected in this test
- ④ Connect SG terminal and FG terminal of EUT to ground plane

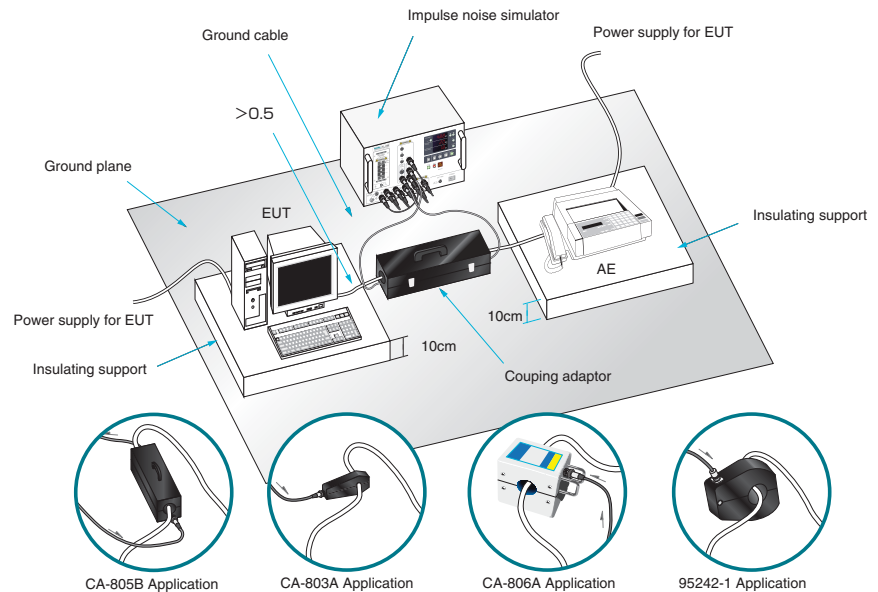

Application Example of Probes

Pulse generation principle of Noise simulator

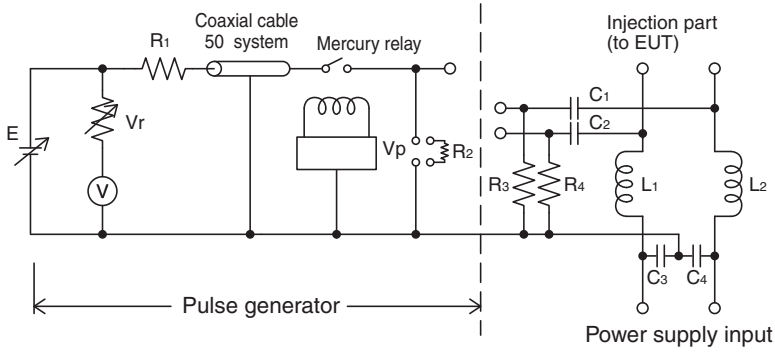

Frequency spectrum

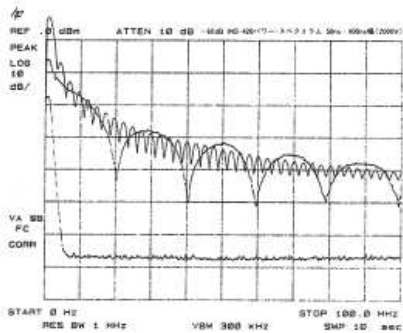

Waveform of Noise Simulator

Output voltage waveform

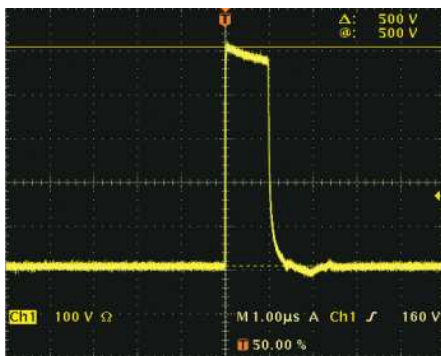

500V/div. 1µs/div

Waveform at rise-up

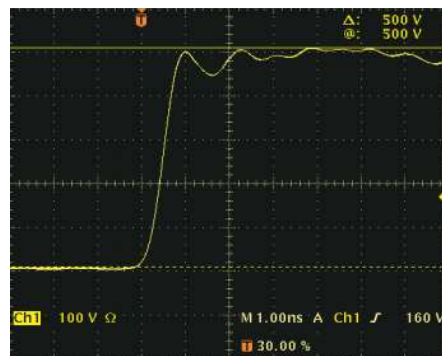

500V/div. 1ns/div