

# Where power meets precision

PX8000  
Precision Power Scope

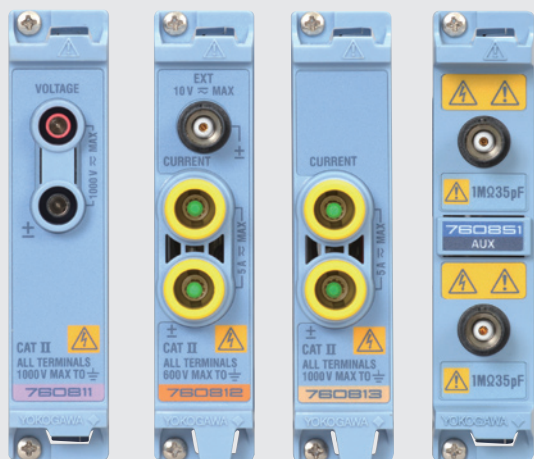

**The PX8000 brings together Yokogawa's world-leading expertise in power measurement with our long heritage in oscilloscope design to deliver a true test and measurement revolution: the world's first precision power scope.**

**With the launch of the PX8000, R&D professionals need no longer compromise on their need for high-accuracy time-based power measurement, a need that conventional power analyzers and oscilloscopes were never designed to meet.**

**As more and more innovation focuses on energy consumption and the integration of electronics into power-based systems, so more and more engineers are demanding accuracy and precision from their power measurement.**

The PX8000 delivers:

**Insight** – Precision power measurement gives true insights into energy consumption and performance.

**Confidence** – Proven, high-quality production means the PX8000 can be relied upon to deliver over extended periods of time.

**Familiarity** – Users experience a short learning curve thanks to features familiar to anyone who's used to power measurements or oscilloscopes.



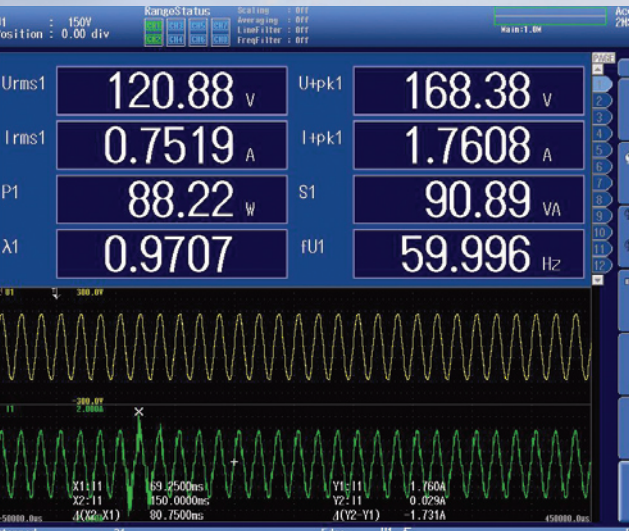



# Features and benefits

## Transient power measurement and analysis

The PX8000 has a number of innovative features that support the crucial measurement and analysis of transient power profiles.

2



### Simultaneous power calculation

The PX8000 provides simultaneous voltage and current multiplication to give real-time power sampling. This supports both transient measurement (as standard) and numerical values averaged across the sample period. The available measurement period will depend on the sample rate and the memory size.

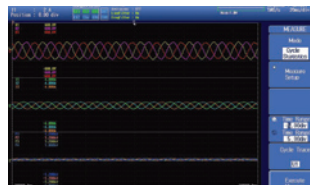

### Cycle-by-cycle power trend measurement

Trend measurements between waveforms can be calculated by mathematical functions (up to four million points). The PX8000 provides graphical displays of voltage, current and power readings. The waveforms can be inspected for specific numerical values at any point and averages can be calculated between start and stop cursors.

Such capabilities are particularly important when analyzing and optimizing the performance of, for instance, lighting and electric motors at start-up.

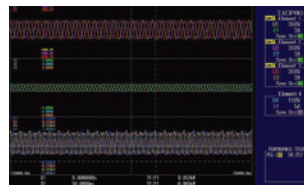

### Specific time-period measurement

The PX8000 supports the capture of power waveforms over specific periods of time through the definition of start and stop “cursors”. This is particularly useful for examining transient phenomena and in the design of periodically controlled equipment. To ensure that equipment such as photocopiers complies with energy standards, for instance, it is vital to measure power consumption across a range of different modes from “sleep” to full activity – and all the transient states in between.



### X-Y display and phase analysis

For certain tasks it is important to be able to display values on an X-Y axis. Motors, for instance, are characterized by an ST-curve that shows the relationship between speed and torque. The PX8000 supports such displays as standard. It can also display lissajous waveforms of input and output for phase analysis.



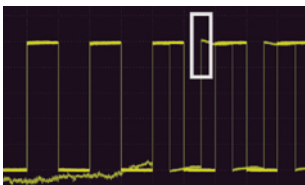

### Capturing sudden or irregular phenomena

Abnormal phenomena discovered during repeated high-frequency measurements can often be hard to isolate, disappearing from the screen almost as soon as they appear. The PX8000 has an always-active History function that automatically records up to 1000 historical waveforms. These waveforms can be recalled and redisplayed at any time. They can also be used to redefine trigger conditions.

Historical waveforms are explored via condition-based searches. Specific abnormal phenomena, for instance, can be located by searching only for waveforms that cross – or do not cross – a certain rectangular zone. Other search parameters include waveform amplitude and RMS.

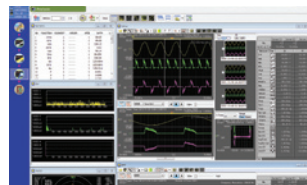

### Long-period data capture and analysis

A PC application software for the PX8000, called PowerViewerPlus, can be used to capture waveform data for further analysis. This extends the ability of the PX8000 to use mathematical functions to analyze longer term performance.

PC connection is via standard Ethernet/USB/GP-IB connections. The user-friendly software displays waveforms in a simple and clear graphical style that will be familiar to users of Yokogawa's popular Xviewer software.

Researchers who want to use their own analysis software will be able to establish a connection to the PX8000 via the LabVIEW driver.

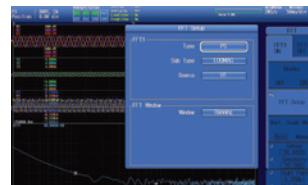

### FFT analysis

The PX8000 features arithmetical, time-shift, FFT and other computations that enable users to display waveforms with offsets and skew corrections. Users can also define their own computations via equations that combine differentials, integrals, digital filters and a wealth of other functions.



### Simultaneous harmonic measurement

The PX8000 makes it possible to simultaneously measure the harmonic components of voltage and current waves as well as the harmonic distortion factor. Harmonic measurements take place in parallel with conventional voltage and current measurement. Harmonics up to the 500th order of the fundamental can be measured.

# The PX8000 in detail

- 1 Display format selection:**  
Comprehensive range of display functions for power analysis, including numeric/waveform/vector/bar/X-Y graphs.
- 2 Wiring selection:**  
Choose between different wiring, according to the relevant electricity system: single-phase, two- and three-wire (1P2W/1P3W/3P3W) and three-phase, three- and four-wire (3P3W/3P3W(3V3A)/3P4W) connectivity.
- 3 Acquire settings:**  
Memory size setting and History function for displaying and analyzing irregular waveform data. Sampling frequency is determined by memory size and time axis selections.
- 4 Module parameter settings:**  
Measurement parameters and options include voltage/current (direct/sensor) ranges, auto-ranging, offset, vertical zoom, filter, scaling and synchronized sources.
- 5 Power analysis settings:**  
Analytical functions include cycle-by-cycle trend calculation, specific time-period measurement, and harmonic analysis and FFT analysis. There is a null setting for capturing sensor input conditions.





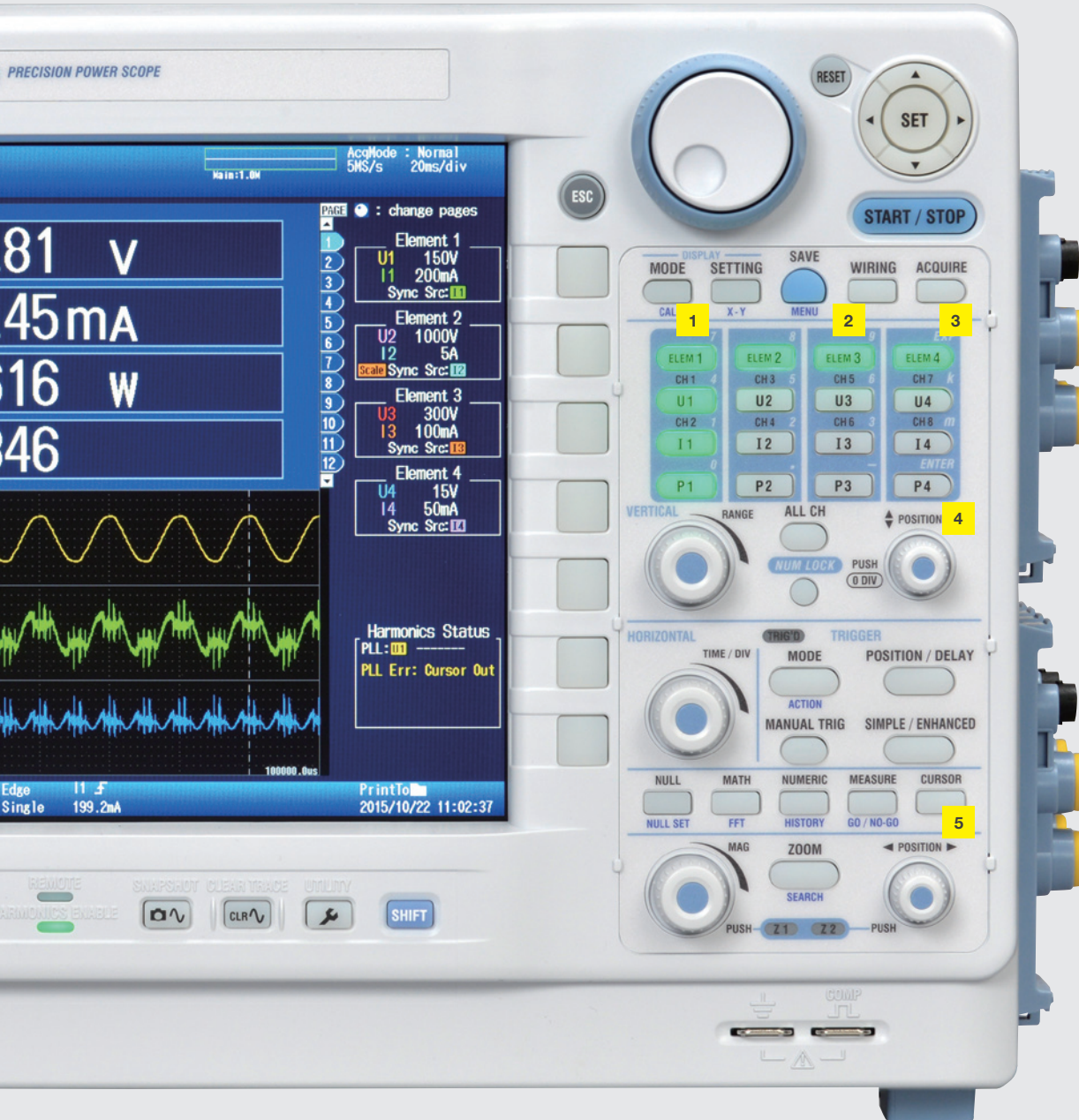

# Modules



### De-skewed measurement set-up

Sensors can introduce phase errors or skew between the current and voltage inputs.

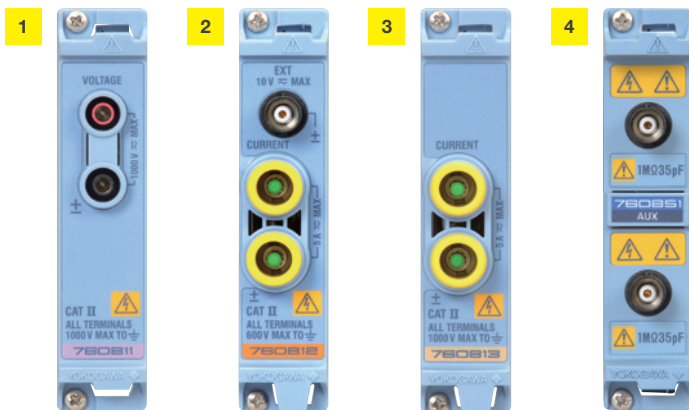

- 1 Voltage module**  
 12-bit sampling at up to 100 MS/s  
 DC to 20 MHz bandwidth\*  
 1.5 V to 1000 Vrms direct input  
 45 Hz to 1 kHz accuracy:  $\pm(0.1\%$  of reading,  $+0.1\%$  of range)

- 2 3 Current module**  
 12-bit sampling at up to 100 MS/s  
 DC to 10 MHz bandwidth\* (direct input)  
 DC to 20 MHz bandwidth\* (sensor voltage input, 760812)  
 10 mA to 5 Arms direct input  
 50 mV to 10 Vrms sensor input (760812)  
 45 Hz to 1 kHz accuracy:  $\pm(0.1\%$  of reading,  $+0.1\%$  of range)

Power measurement element includes voltage and current module (up to four modules).

- 4 Sensor and voltage measurement module (up to three modules can be installed)**  
**Auxiliary (AUX) module**

12-bit sampling at up to 100 MS/s  
 DC to 20 MHz bandwidth\*  
 Up to 200 V (DC+ACpeak) via direct input  
 Up to 1000 V (DC+ACpeak) via probe input  
 Accuracy:  $\pm 1\%$  of range (DC)  
 Torque and speed sensor inputs  
 Pulse input from 2 Hz to 1 MHz

\* Bandwidth is specified at  $-3$  dB point

### Safety and error-prevention features

To prevent incompatibilities, the PX8000 will detect miss-matched current and voltage modules and flag them with an on-screen warning message.

The PX8000 also comes with a range of standard dedicated input connectors designed to prevent incorrect or dangerous power connections. Using these connectors, it is not possible, for instance, to connect a current to a voltage input terminal.

A tie-wrap system prevents accidental current terminal disconnection.





# Connectivity

7

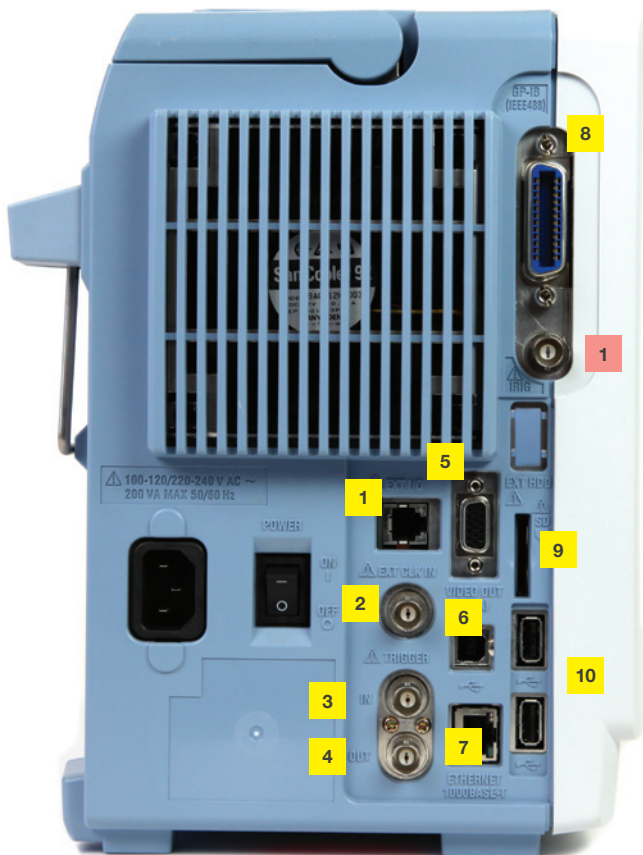

## Long phenomena capture

The large internal memory of up to 100 M Points enables long term measurements to be made at high and appropriate sample rates.

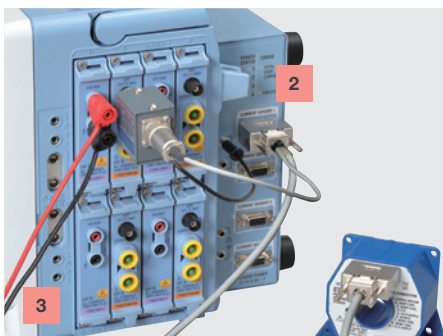

- Error for when used in conjunction with the AC/DC current sensor  
Add the error of the AC/DC current sensor and that of the power analyzer.

- 1 EXT I/O**  
The PX8000 can be used to send a GO/NO-GO signal based on set conditions; equally external signals can be used to trigger measurement and analysis.
- 2 EXT CLK IN**  
Sampling can be timed to an external signal (up to 9.5 MHz)
- 3 TRIGGER IN**  
External trigger input
- 4 TRIGGER OUT**  
External trigger output
- 5 VIDEO OUT**  
Video signal output for enhanced display on analog RGB displays
- 6 USB-PC**  
Enables control from a PC
- 7 Ethernet**  
1000 BASE-T comes as standard
- 8 GP-IB**  
General purpose interface bus
- 9 SD card slot**  
SD- and SDHC-compliant (Up to 16 GB)
- 10 USB**  
For connection to a range of peripherals including storage, keyboard and mouse
- 1 IRIG (/C20 option)**  
Synchronize multiple instruments via an external time source
- 2 Power supply for sensors (/PD2 option)**  
4 outputs,  $\pm 15$  Vdc, Max. 1.8 A/CH  
Dedicated shunt boxes and cables are prepared as well.
- 3 Power supply for probes (/P4 option)**  
4 outputs,  $\pm 12$  Vdc, Total 1 A

# Power meets precision

R&D teams everywhere are coming to terms with the need for new levels of precision in power measurement. With pervasive microprocessor control and on-going pressure to reduce energy consumption, the lines between electrical and electronic engineering continue to blur – and the need for a new class of hybrid measurement is emerging.

Traditional power measurement instruments cannot provide accurate time measurements; oscilloscopes are not designed to measure power. The PX8000 is the world's first precision power scope, bringing oscilloscope-style time-based measurement to the world of power measurement.

The PX8000's time-based accuracy brings a new dimension to power analysis. It can capture voltage and current waveforms precisely, opening up applications and solutions for a huge variety of emerging power measurement problems.

## The Yokogawa power analyzer series

The PX8000 is the new flagship product for Yokogawa's range of industry-proven power analyzers. Yokogawa's first power measurement instrument was designed back in the 1960s, and its power analyzers have played an important role in sustainable industrial development ever since.

## Focus on precision

The PX8000 brings high-precision waveform capabilities to power measurement. Among the features unique to the PX8000 are:

### Multifunction snapshots

Up to 16 different waveforms – including voltage, current and power – can be displayed side-by-side, giving engineers instant snapshots of performance.

### Detailed transient analysis

The PX8000 supports the measurement of all power waveform parameters between precisely defined start and stop cursors.

### Trend calculation

The PX8000 has built-in functions for the direct calculation of variables, such as root mean square (RMS) and mean power values, to enable the identification of cycle-by-cycle trends.

### De-skew compensation

The PX8000's de-skewing function eliminates offsets between current and voltage signals that may be caused by sensor or input characteristics.

## isoPRO™ – pioneering measurement technology



The PX8000 is powered by Yokogawa's isoPRO™ technology, which offers industry-leading isolation performance at the highest speeds. isoPRO core technology, designed with energy-saving applications in mind, delivers the performance needed to develop high-efficiency inverters that operate at high voltages, large currents and high frequency.



9 **Focus on power**

**Innovators everywhere are focusing on key questions that can only be answered by measuring power precisely.**

- How can we minimize energy loss?
- How can we boost performance?
- How can we efficiently use renewable energy sources?

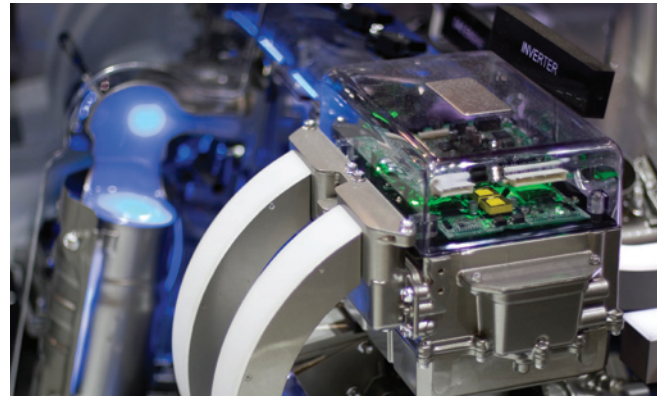

Inverter performance and efficiency



Photovoltaic cells for solar power

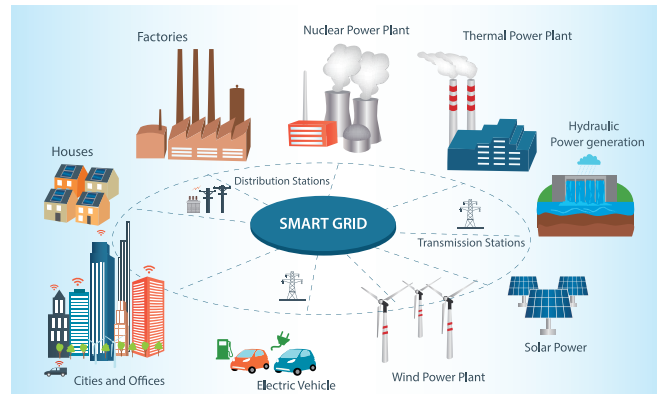

Smart grid solutions



Electric/hybrid vehicles



Wireless power charging

# Applications

The PX8000 is an immensely versatile instrument, unlocking precision power measurement capabilities for researchers working on everything from renewable power to advanced robotics. Anywhere that power consumption is at a premium – which means almost anywhere power is consumed – can benefit from the introduction of the PX8000's precision measurement and analysis capabilities.

The following pages cover some typical applications for the PX8000. For help in designing your own measurement strategy, please contact your usual Yokogawa representative.



10

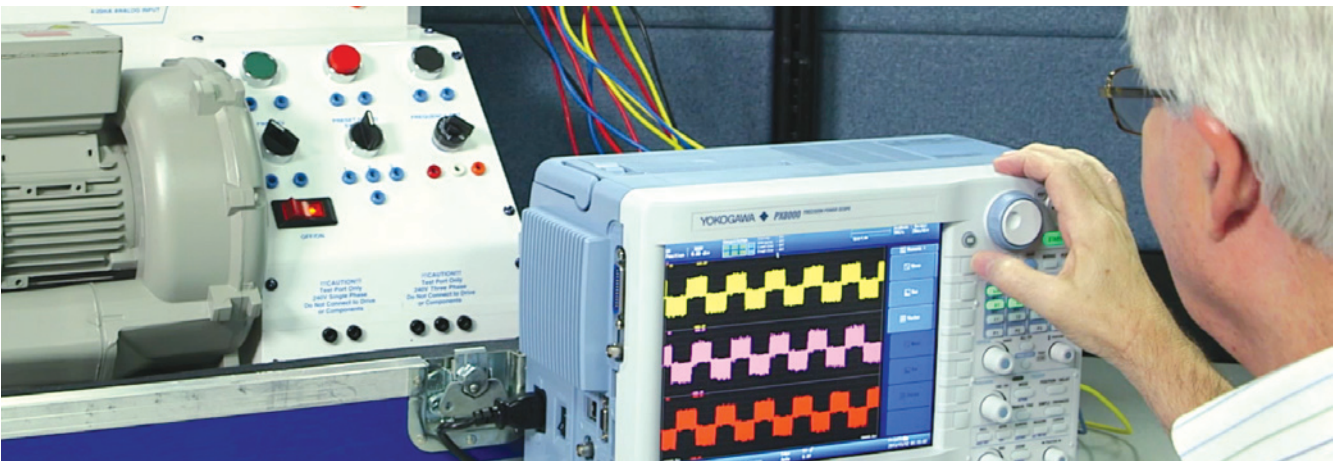
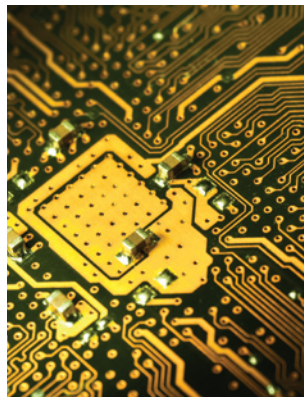

# Inverter and motor testing

## Overview

Electric and hybrid vehicles have many electrical and mechanical components, and overall performance evaluation requires measuring the efficiency of both. The PX8000's flexibility, accuracy and wide bandwidth make it ideal for drawing together the range of power readings needed to optimize the efficiency of boost circuits and inverters – two key elements in overall electric vehicle performance.

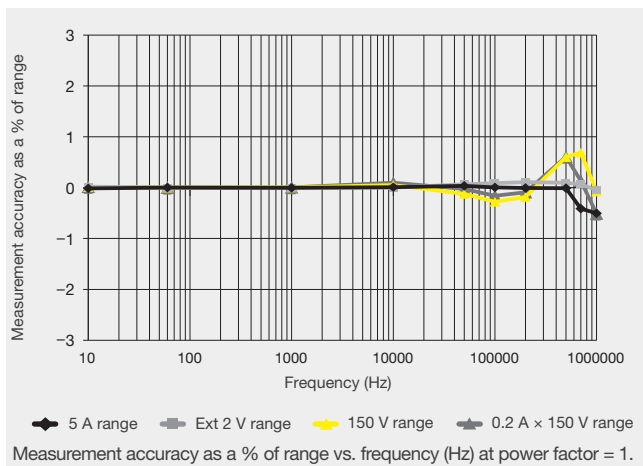
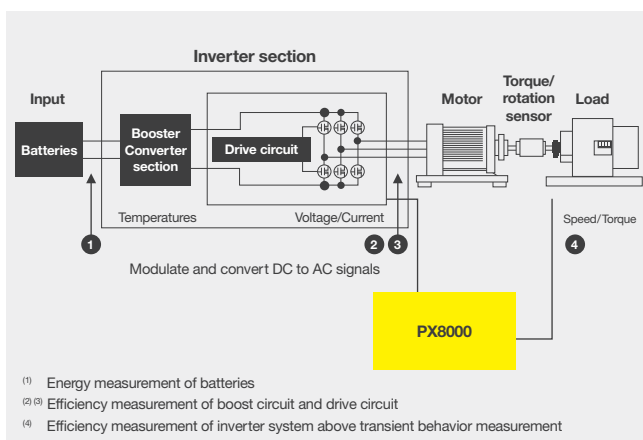

## The PX8000 advantage

### Wide bandwidth

The vertical resolution of analog/digital conversion is one of the most important factors in precision measurement. The PX8000 has 12-bit resolution with 100 MS/s sampling and 20 MHz bandwidth. This means the PX8000 can be used for accurate measurement of inverter pulse shapes, which can then be used to fine-tune inverter efficiency.

### Transient measurement by cycle-by-cycle trend

The PX8000's ability to analyze cycle-by-cycle trends makes it ideal for the measurement of transient effects. During the start-up phase of an inverter and motor, for example, current increases can be analyzed in each cycle. And when the load changes rapidly, the engineers can gain insights that will enable them to improve the control of the inverter.

### Harmonic and FFT analysis

The PX8000 has both harmonic and FFT measurement capabilities for frequency-based analysis. The Harmonic function can measure fundamental waveforms from 20 Hz to approximately 400 kHz. This is particularly useful for analyzing higher harmonic component and causes of noise in electromechanical systems.

### Offset cancels by individual NULL function

A common problem when testing inverter motors is the presence of ambient noise that can mean test values are nonzero even before testing begins. The PX8000's offset capabilities mean such effects can be nullified and specific inputs can be isolated for testing and analysis.



# Reactor loss measurement of inverter boost circuits

## Overview

A reactor is used to filter out noise and boost voltage levels prior to the use of an inverter. It consists of an electromagnetic material core and a coil. A main focus for electrical engineers is to reduce power loss across the total inverter system, and reactor performance is of particular interest. There are two potential evaluation methods: direct loss measurement of the reactor and iron loss measurement. The PX8000 supports either methodology because it can accommodate both high frequency measurement and low-power-factor conditions.

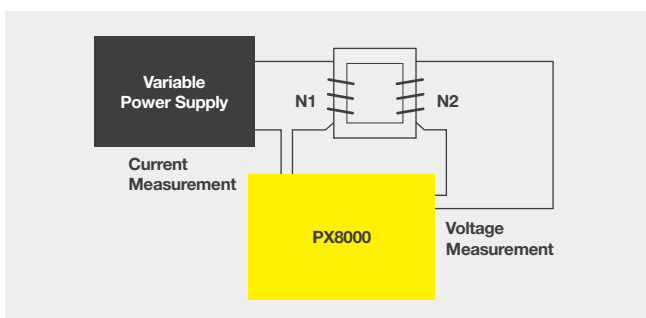
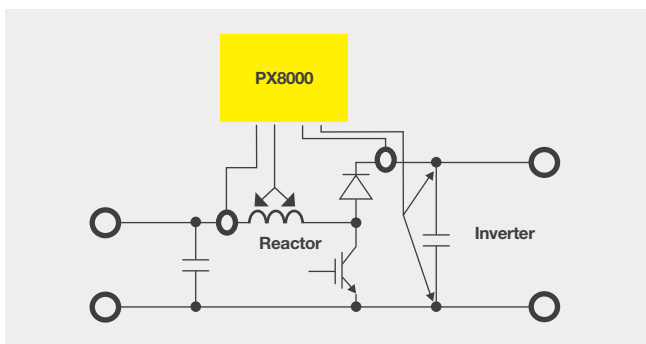

## The PX8000 advantage

### Low-power-factor measurement

Higher sampling rates and broad bandwidth make the PX8000 particularly useful for testing devices, such as transformers and reactors, that have lower power factors. It is particularly important to measure the precise power consumption of such devices at high frequency.

### De-skew functionality

To analyze power consumption in low-power-factor devices it is particularly important to minimize any time differences between voltage and current caused by sensor input characteristics. The PX8000 provides precise de-skew adjustment to compensate for this time difference.

### Core loss measurement under high frequency

Analyzing reactor core loss is an example of how the PX8000's user-defined functions can be utilized to provide an instant analysis of system performance.

In this example, core loss is calculated based on primary coil current and secondary coil voltage (using readings from an Epstein device), while magnetic flux density (B) and magnetic field (H) are calculated by factoring in input frequency, cross-sectional area and other parameters. All values can be displayed directly by the PX8000.

$$\text{Core loss} = \text{Power value (W)} \times \frac{N1}{N2}$$

Measurement items specified using user-defined function as follows:

$$B = \frac{\text{Voltage (mean)}}{\sqrt{2} \pi \times \text{Current freq.} \times N2 \times \text{cross section}}$$

$$H = \frac{N1 \times \text{Primary coil peak current}}{\text{Effective magnetic path length}}$$

# Transient responses of industrial robots

## Overview

To evaluate motor-driven robots, power consumption of all motors and controllers are measured throughout all operational speeds and action patterns. Design engineers need to measure inrush voltage, current and power over the pattern of repeated actions. Efficiency is calculated by comparing mechanical output with input power.

During actual operating conditions, the time to accelerate and decelerate such motors can range from several hundred milliseconds to several seconds. As a PWM-driven motor rotates from the reset position to the top speed, the drive frequency changes from DC to several hundred Hz.

The PX8000 gives design engineers insight into power consumption and efficiency throughout a robot's operational performance.

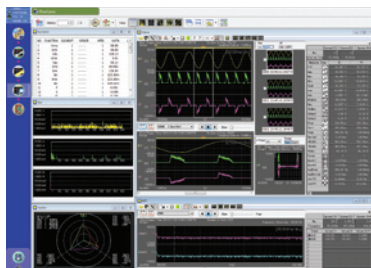
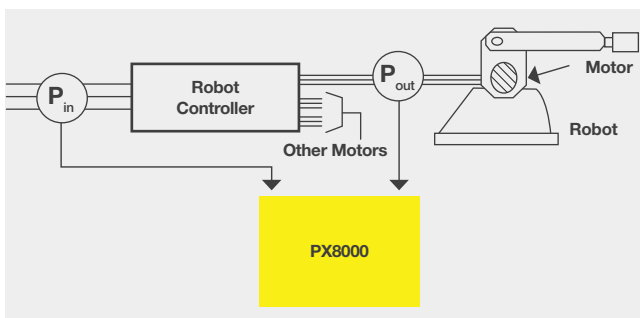

PowerViewerPlus

## The PX8000 advantage

### Specific time-period analysis

The PX8000 supports the measurement of waveform data between specific Start/Stop cursors. Combined with its multi-channel capabilities and its Long memory and History functions, this makes the PX8000 particularly useful in rating a robot's operational power consumption.

### Efficiency measurement of boosters, inverters and motors

A single PX8000 unit can measure both the input/output power of inverters and the mechanical output of a motor. By installing three power units and one AUX module, the PX8000 can be configured to provide an instantaneous measure of component efficiency.

### Transient measurement by trend computation

With its instantaneous power calculations, the PX8000 is ideal for evaluating and optimizing transient effects. Its cycle-by-cycle trend analysis provides further insights into this crucial area of robotics engineering.

### Longer time-period measurement

To analyze some robotic operations, it may be necessary to perform cycle-by-cycle trend analysis over a long period of time up to 20 minutes. The PowerViewerPlus software extends this mathematical capability to enable deep insights to be obtained from the data.

# Wireless charger efficiency measurement

## Overview

The development of wireless charging technology for mobile devices like smartphones and tablet devices is a focus for research. Automotive manufacturers are looking into the possibilities of charging electric vehicles wirelessly too.

Wireless charging depends on two electromagnetic coils being configured to support particular frequency profiles. Efficient power transfer and the prevention of power loss are naturally particularly important. The PX8000 is ideally suited for measuring such systems because of its ability to operate at high frequencies up to several hundred kHz and low power factors.

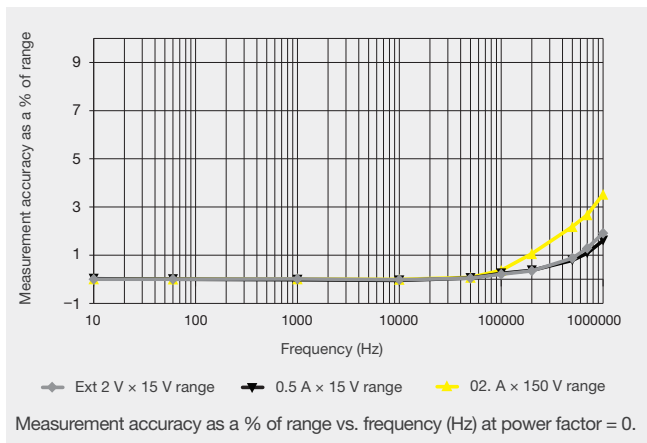

## The PX8000 advantage

### Wireless charger efficiency evaluation

To evaluate the efficiency of wireless transfer (including inverters), at least three power measurement elements are required. The PX8000, with its four input channels, can analyze the performance of the whole system simultaneously.

### Low-power-factor device measurement

The PX8000's higher sampling rates and broad bandwidth make it ideally suited for wireless power transfer systems. (The PX8000 supports 12-bit resolution, sample rates of up to 100 MS/s and a 20 MHz bandwidth.) Crucially, this means the PX8000 supports the measurement of low-power-factor systems operating at very high frequencies.

### De-skew functionality

Because the PX8000 provides a de-skew function, differences between voltage and current that are introduced by sensor and input characteristics can be compensated for and therefore eliminated from the analysis of low-power-factor systems.

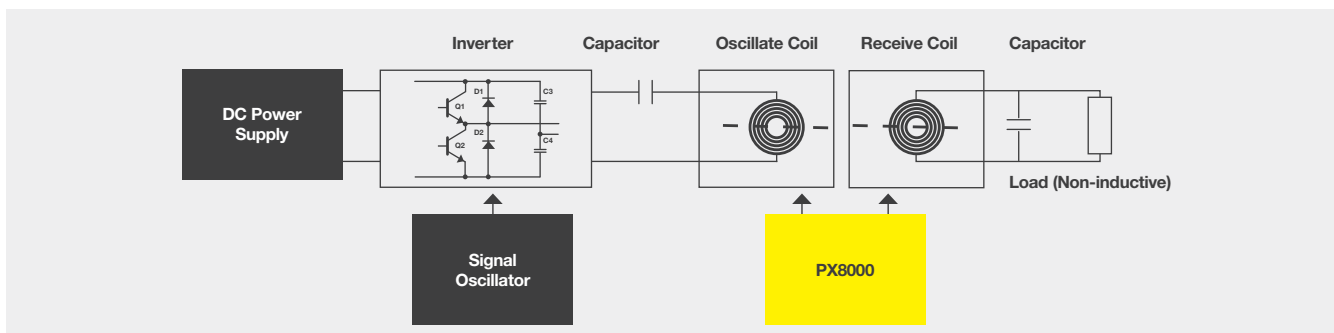



# Power distribution

## Overview

Power distribution systems have to maintain constant voltage and constant power during load switching or in the case of a short circuit. Distribution protectors or circuit breakers for three-phase electricity systems must therefore be tested at transient voltage and power levels.

The PX8000 can capture fluctuating voltage and current waveform, calculate power parameters (including voltage and current values), determine an average over a specified period and display all values.

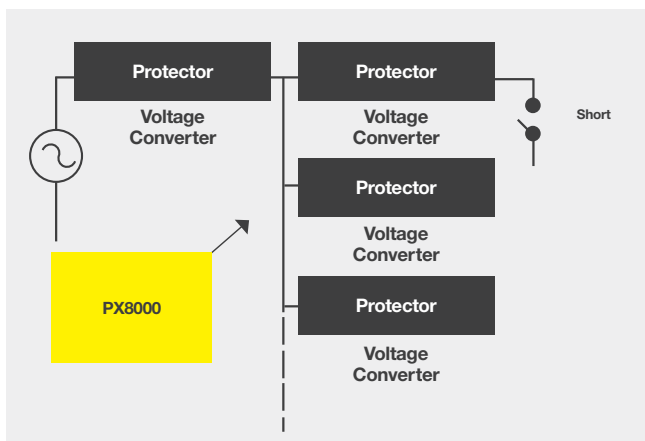

## The PX8000 advantage

### Simultaneous three-phase data capture

To evaluate three-phase electrical systems, at least three power measurement inputs are required. The PX8000 not only has four inputs but also enables the simultaneous capture and display of voltage and current across all three phases.

### Specific time-period measurement

For a true evaluation of distribution protection, it is necessary to measure a full cycle of voltage, current and power values half a cycle after the recovery from a short circuit. The PX8000 can easily be set up to focus on such a specific period.

### Harmonic and FFT analysis

The PX8000 has capabilities for both harmonic measurement and FFT for frequency analysis. The harmonic function can measure fundamental frequencies from 20 Hz to approximately 400 kHz, and FFT has 1 k to 100 k points calculation across up to two channels. Such measurements are vital for identifying harmonic currents and identifying sources of noise.

## Specifications of PX8000 and the modules

Input	
Shape	Plug-in input module style
Module structure	Voltage module, Current module and Auxiliary (AUX) module Power measurement element: one Voltage module and one Current module Maximum 8 modules (maximum 4 power measurement elements) can be installed AUX module can be installed maximum 3 (at least one power measurement elements must be installed).
Maximum channel number	8 ch, combination of Voltage/Current modules and AUX module
Maximum record length	Standard 10 M points for each voltage and current regardless of the installed number of modules. The memory cannot be combined, each memory of module is individual. 50 M points for each voltage and current regardless of the installed channel number of input modules when /M1 option is installed. 100 M points for each voltage and current regardless of the installed channel number of input modules when /M2 option is installed.
Voltage/Current input modules (760811/760812/760813) Specifications	
Input terminal type	Voltage: Plug-in terminal (female) Current: Direct input: Plug-in terminal (male) External current sensor input: isolated BNC (760812)
Input format	Voltage: Floating input, resistive voltage divider Current: Floating input through shunt
Measurement range	Voltage: 1.5/3/6/10/15/30/60/100/150/300/600/1000 Vrms (crest factor = 2 at rated range input) Current: Direct input (5 A) 10 m/20 m/50 m/100 m/200 m/500 m/1/2/5 Arms (Crest factor = 2 at rated range input) Current: External current sensor input (760812) 50 m/100 m/200 m/500 m/1/2/5/10 Vrms (Crest factor = 2)
Line filter	Select from OFF, 500 Hz, 2 kHz, 20 kHz, and 1 MHz.
Frequency filter	Select from OFF, 100 Hz, 500 Hz, 2 kHz and 20 kHz.
A/D converter	Resolution: 12 bit
Max sample rate	Conversion ratio (sampling period): Approx. 10 ns. (100 MS/s) For harmonic measurement, please refer to harmonic function.
Auxiliary (AUX) module (760851) Specification	
Number of input channels	2, switchable analog or pulse input
Input coupling	AC, DC, or GND
Input format	Isolated unbalanced
Frequency characteristics	DC to 20 MHz (-3 dB point when sine wave of amplitude ±3 div is applied)
Voltage-axis sensitivity setting	50 mV to 100 V (1:2.5-5 steps) (when using 1:1 probe attenuation)
A/D conversion resolution	12 bit
Temperature coefficient	±(0.1% of range/°C) (typical)
Bandwidth limit	Select from OFF, 2 MHz, 1.28 MHz, 640 kHz, 320 kHz, 160 kHz, 80 kHz, 40 kHz, 20 kHz, and 10 kHz Cut-off characteristics: -18 dB/OCT (when 2 MHz, Typical)
Accuracy (analog)	DC: ±1% of range (typical) * Measured under the standard operating conditions
Frequency measurement range	2 Hz to 1 MHz, displaying range: 1.8 Hz to 2 MHz
Pulse width	500 ns or wider
Accuracy (pulse)	±(0.05% of reading) ±1 count error (10 ns). Except, the observation time is greater or equal to 300 times the period of the pulse.
Trigger Function	
Trigger mode	Auto, Auto Level, Normal, Single, N Single, or On Start
Simple Trigger	
Trigger source	Un, In, Ph, AUXn, EXT, LINE, or Time n = channel number
Time Trigger	Date (year, month, and day), time (hour and minute), and time interval (10 seconds to 24 hours)
Enhanced trigger	
Trigger source	Un, In, Ph, AUXn or EXT
Trigger type	A → B(N); A Delay B; Edge on A; AND; OR; B>Time; B<Time; B Time Out; B Between; Period; T>Time; T<Time; T1<T2; T<T1; T<T2; Wave Window
Time Base	
Time axis setting (Observation time) *Time/div	Time/div setting: 100 ns/div to 1 s/div (1-2-5 step), 2 s/div, 3 s/div, 4 s/div, 5 s/div, 6 s/div, 8 s/div, 10 s/div, 20 s/div, 30 s/div, 1 min/div and 2 min/div Observation time: 1 μs to 1200 s
Display	
Display	10.4 inch TFT LCD display
Number of dots	1024 × 768 XGA
Waveform displaying dot size	801 × 656 (Waveform Display)
Displaying format	Combination: Maximum 2 types of format can be displayed Numeric 4 items/ 8 items/ 16 items/Matrix/All/Single List/Dual List/Custom Wave 1/2/3/4/6/8/12/16 Bar Single/Dual/Triad Vector Single/Dual ZOOM1 and ZOOM2 (divided lower display area) FFT1 and FFT2 (divided lower display area) XY1 and XY2 (divided lower display area)
Display update	Depends on setting of observation time and record length
Numerical Display	
Maximum digit of numeric display	Selected full 5 digits (displaying 99999), or 6 digits (999999)
Number of displayed items	Select from 4, 8, 16, Matrix, All, Single List, Dual List, and Custom
Waveform Display	
Displaying items	Maximum 16 waveforms Voltage, current and power of Element 1 Voltage, current and power of Element 2 (or AUX3 and AUX4 of Element 2) Voltage, current and power of Element 3 (or AUX5 and AUX6 of Element 3) Voltage, current and power of Element 4 (or AUX7 and AUX8 of Element 4) MATH 1 to MATH 8
Vector Bar Graph Display (option)	
Vector display	Display the phase angle between the fundamental voltage signal and fundamental current signal as a vector
Bar graph display	Display a bar graph of the amplitude of each harmonics when it is harmonic measurement.

## PX8000

Zoom Display																									
Zoom	Expand the displayed waveform along with the time axis (up to 2 separate locations). The zoom position can be automatically scrolled.																								
FFT Display																									
FFT	Power spectrum of input waveform, Maximum two windows																								
X-Y display																									
X-Y Display	The X and Y axes can be selected from Un/In/Ph/AUXn, MATHn (Maximum four traces, two windows).																								
Measurement Function and Conditions																									
Crest Factor	Up to 200 (effective minimum input), Up to 2 (rated input) CrF: Voltage crest factor, CrI: Current crest factor																								
Measurement period	Measurement period to calculate numerical values - Period of measurement update cycle based on zero crossing or external gate signal source signal - 8192 points for harmonic measurement from specified start cursor																								
Wiring method	1P2W (Single phase 2 wire), 1P3W (Single phase 3 wire), 3P3W (3 phase 3 wire), 3V3A (3 phase 3 wire, 3 power meter method), 3P4W (3 phase 4 wire)																								
Scaling	0.0001 to 99999.9999 can be set for scaling of VT ratio, CT ratio and power ratio when external current sensor, VT or CT are used for the input Linear scaling function is available for AUX module (760851)																								
Frequency measurement																									
Number of displayed digits	Full 5 digits (99999)																								
Max frequency	5.0000 MHz																								
Accuracy	±0.1 of reading																								
Frequency Measurement filter	Same as Zero-cross filter (OFF/100 Hz/500 Hz/2 kHz/20 kHz)																								
Harmonics measurement																									
Method	PLL synchronization method (not available for external sampling clock function)																								
Frequency range	The range for the fundamental frequency of the PLL source is 20 Hz to 409.6 kHz, and sampling frequency is more than 2 MS/s. Time/div is 2 ms/div or higher. ACQ Time Base is set to Int (EXT TRG IN source: 20 Hz to 6.4 kHz)																								
FFT data length	8192, the analysis (calculation) start point can be set freely in the acquisition memory data. Acquisition data length is required twice of window length.																								
Window function	Rectangular																								
Sample rates, window width and upper limits of harmonic analysis	<table border="1"> <thead> <tr> <th>Fundamental freq.</th> <th>Sample rate</th> <th>Window width</th> <th>Upper limit of harmonics</th> </tr> </thead> <tbody> <tr> <td>20 Hz to 600 Hz</td> <td>f × 1024</td> <td>8 cycles</td> <td>500 order</td> </tr> <tr> <td>600 Hz to 1200 Hz</td> <td>f × 512</td> <td>16 cycles</td> <td>255 order</td> </tr> <tr> <td>1200 Hz to 2600 Hz</td> <td>f × 256</td> <td>32 cycles</td> <td>100 order</td> </tr> <tr> <td>2600 Hz to 6400 Hz</td> <td>f × 128</td> <td>64 cycles</td> <td>50 order</td> </tr> <tr> <td>6.4 kHz to 409.6 kHz</td> <td>f × 64</td> <td>128 cycles</td> <td>30 order</td> </tr> </tbody> </table> (Minimum sample rates are specified.)	Fundamental freq.	Sample rate	Window width	Upper limit of harmonics	20 Hz to 600 Hz	f × 1024	8 cycles	500 order	600 Hz to 1200 Hz	f × 512	16 cycles	255 order	1200 Hz to 2600 Hz	f × 256	32 cycles	100 order	2600 Hz to 6400 Hz	f × 128	64 cycles	50 order	6.4 kHz to 409.6 kHz	f × 64	128 cycles	30 order
Fundamental freq.	Sample rate	Window width	Upper limit of harmonics																						
20 Hz to 600 Hz	f × 1024	8 cycles	500 order																						
600 Hz to 1200 Hz	f × 512	16 cycles	255 order																						
1200 Hz to 2600 Hz	f × 256	32 cycles	100 order																						
2600 Hz to 6400 Hz	f × 128	64 cycles	50 order																						
6.4 kHz to 409.6 kHz	f × 64	128 cycles	30 order																						
Accuracy	Line filter OFF Add below expression to normal measurement Voltage & current: (0.001 × f + 0.001 × n)% of reading + 0.1% of range Power: (0.002 × f + 0.002 × n)% of reading + 0.2% of range f: unit kHz																								
Waveform data acquisition and display																									
Acquisition mode	Normal: Normal waveform data acquisition Envelope: The peak values are held at the maximum sample rate regardless of the Time/div setting. Averaging: The number of times to average can be set to 2 to 65536 in 2 <sup>n</sup> steps.																								
Zoom	Expand the displayed waveform along with the time axis (up to 2 separate locations). The zoom position can be automatically scrolled.																								
Display format	1/2/3/4/6/8/12, and 16 analog waveform windows																								
Snapshot	The currently displayed waveforms can be retained on the screen. Snapshot waveforms can be saved and loaded.																								
Vertical and Horizontal Control																									
Channel ON/OFF	Un, In, Ph, AUXn or MATHn can be turned ON and OFF separately																								
Vertical axis zooming	× 0.1 to × 100 Upper and lower limits can be used to set the scale.																								
Roll Mode	Roll mode is enabled automatically when the trigger mode is set to Auto, Auto Level, Single, or On Start, and the time axis setting is greater than or equal to 100 ms/div.																								
Analysis Functions																									
Power parameters calculation	Calculate Voltage, Current, Power, Delta parameters, frequency and AUX values from captured waveforms Apparent power, reactive power and power factor and those Sigma values are calculated from the Voltage, Current and Power values																								
Automated measurement of Waveform parameters	Up to 24 items can be displayed P-P, Amp, Max, Min, High, Low, Avg, Mid, Rms, Sdev, +OvrShoot, -OvrShoot, Rise, Fall, Freq, Period, +Width, -Width, Duty, Pulse, Burst1, Burst2, AvgFreq, AvgPeriod, Int1TY, Int2TY, Int1XY, Int2XY, Int1hXY (IntegPower/IntegCurrent) Int2hXY (IntegPower/IntegCurrent)																								
Statistical processing	Application items: Automated measurement values of waveform parameters Statistical items: Max, Min, Avg, Sdev, and Cnt																								
Cyclic statistical processing	Automatically measures the waveform parameters of the data in the acquisition memory and performs statistical processing on the parameters once per period.																								
User defined computation (MATH)	Maximum 8 expressions for waveforms MATH1 to MATH8, Maximum 4 Mpoint, regarding Digital filter +, -, /, SHIFT, ABS, SQRT, LOG, EXP, NEG, SIN, COS, TAN, ATAN, PH, DIF, DDIF, INTG, INTG, BIN, SQ, CUBE, F1, F2, FV, PW/H, PW/L, PW/LH, PW/LL, PW/XX, DUTY/H, DUTY/L, FLT1, FLT2, H.LBT, MEAN, LS, PS, PSD, CS, TF, CH, MAG, LOGMAG, PHASE, REAL, IMAG, TREND, TRENDM, TREND0, TRENDF, _HH, _LL, _XX and ZC																								
User defined computation (numeric)	Maximum 20 expressions, F1 to F20 +, -, /, ABS, SQRT, LOG, EXP and NEG																								
De-skew function	Compensate the phase difference between voltage and current modules of a power measurement element																								
GO/NO-GO determination	Two types of GO/NO-GO determination are available																								
File Functions																									
Save	Setup data, Waveform data (including History data), Numeric data and Image data can be saved external media.																								
Load	Waveform data (including History data up to 1000 waveform) and setup data																								
FFT Function																									
Waveform to be computed	Un, In, Ph, AUXn and MATHn																								
Number of channels	2																								

Computation range	From the specified computation start point until the specified number of points have been computed
Computed points	1 k, 2 k, 5 k, 10 k, 20 k, 50 k, or 100 k
Time windows	Rectangular, Hamming, Hanning, Flat top, or Exponential

**Built-in Printer (/B5 Option)**

Print system	Thermal line dot system
Sheet width	112 mm

**Storage Functions**

<b>SD Card</b>	
Number of slot	1
Maximum capacity	16 GB
Supported cards	SD and SDHC compliant memory card

**USB Ports for Peripherals**

Compatible USB storage devices	Mass storage devices that are compliant with USB Mass Storage Class Ver. 1.1
--------------------------------	--

**USB Peripheral Interface**

Number of ports	2
Electrical and mechanical specifications	USB Rev. 2.0 compliant
Supported transfer mode	HS (High Speed, 480 Mbps), FS Full Speed, 12 Mbps), and LS Low Speed, 1.5 Mbps)

**Input/Output**

**EXT TRIG IN**

Connector type	BNC
Input level	TTL
Minimum pulse width	100 ns

**EXT TRG OUT**

Connector type	BNC
Output level	5 V CMOS
Logic	Low when a trigger occurs and high after acquisition is completed

**EXT CLK IN**

Connector type	BNC
Input level	TTL
Minimum pulse width	50 ns

**Video Output**

Connector type	D-Sub 15 pin receptacle
Output format	Analog RGB
Output resolution	XGA-compliant output 1024 × 768 dots Approx. 60 Hz Vsync (dot clock frequency: 66 MHz)

**Probe Power Output (/P4 Option)**

Number of output terminals	4
Output voltage	±15 Vdc
Output current	Total maximum of 1 A

**Sensor Power Output (/PD2 option)**

Number of output terminals	4
Output voltage	±15 V
Output current	Maximum of 1.8 A/CH

**Time Sync Signal Input (IRIG: /C20 option)**

Input connector	BNC
Supported IRIG signals	A002, B002, A132, and B122
Input impedance	Can be switched between 50 Ohm and 5 kOhm.
Maximum input voltage	±8 V

**GP-IB**

Connector type	24-pin connector
Electrical specification	Complies with IEEE Std 488-1978 (JIS C 1901-1987)
Functional specification	SH, AH, T6, L4, SR1, RL1, PP0, DC1, DT0, and C0
Protocol	IEEE Std 488.2-1992

**Ethernet**

Connector type	RJ-45 modular jack
Transmission system	Ethernet (1000 BASE-T, 100 BASE-TX or 10 BASE-T)
Communication protocols	TCP/IP

**USB**

Connector type	USB type B receptacle
Electrical and mechanical specifications	USB Rev. 2.0 compliant
Supported transfer modes	HS (High Speed, 480 Mbps) and FS Full Speed, 12 Mbps)

**Accuracy**

Accuracy (at 6 months)	Voltage:	Frequency	Accuracy
			DC: ±(0.2% of reading + 0.2% of range)
		0.1 Hz ≤ f < 10 Hz	±(0.2% of reading + 0.2% of range)
		10 Hz ≤ f < 45 Hz	±(0.2% of reading + 0.1% of range)
		45 Hz ≤ f < 1 kHz	±(0.1% of reading + 0.1% of range)
		1 kHz ≤ f < 10 kHz	±(0.1% of reading + 0.1% of range)
		10 kHz ≤ f < 50 kHz	±(0.2% of reading + 0.2% of range)
		50 kHz ≤ f < 100 kHz	±(0.6% of reading + 0.4% of range)
		100 kHz ≤ f < 200 kHz	±(0.6% of reading + 0.4% of range)
		200 kHz ≤ f < 400 kHz	±(1% of reading + 0.4% of range)
		400 kHz ≤ f < 500 kHz	±(0.1 + 0.003 × f)% of reading + 0.4% of range)
		500 kHz ≤ f < 1 MHz	±(0.1 + 0.003 × f)% of reading + 4% of range)
		1 MHz ≤ f < 10 MHz	±(0.1 + 0.003 × f)% of reading + 4% of range)

\* Measurement bandwidth 20 MHz (-3 dB, Typical)

\* Accuracy over 1 MHz is design value

Current	Direct (up to 5 A)	Frequency	Accuracy
			DC: ±(0.2% of reading + 0.2% of range) + 20 μA
		0.1 Hz ≤ f < 10 Hz	±(0.2% of reading + 0.2% of range)
		10 Hz ≤ f < 45 Hz	±(0.2% of reading + 0.1% of range)
		45 Hz ≤ f < 1 kHz	±(0.1% of reading + 0.1% of range)
		1 kHz ≤ f < 10 kHz	±(0.1% of reading + 0.1% of range)
		10 kHz ≤ f < 50 kHz	±(0.2% of reading + 0.2% of range)
		50 kHz ≤ f < 100 kHz	±(0.6% of reading + 0.4% of range)
		100 kHz ≤ f < 200 kHz	±(0.6% of reading + 0.4% of range)

200 kHz ≤ f < 400 kHz: ±(1% of reading + 0.4% of range)  
 400 kHz ≤ f < 500 kHz: ±(0.1 + 0.004 × f)% of reading + 0.4% of range)  
 500 kHz ≤ f < 1 MHz: ±(0.1 + 0.004 × f)% of reading + 4% of range)

\* Measurement bandwidth 10 MHz (-3 dB, Typical)

Sensor Frequency	Accuracy
	DC: ±(0.2% of reading + 0.2% of range) + 50 μV
0.1 Hz ≤ f < 10 Hz	±(0.2% of reading + 0.2% of range)
10 Hz ≤ f < 45 Hz	±(0.2% of reading + 0.1% of range)
45 Hz ≤ f < 1 kHz	±(0.1% of reading + 0.1% of range)
1 kHz ≤ f < 10 kHz	±(0.1% of reading + 0.1% of range)
10 kHz ≤ f < 50 kHz	±(0.2% of reading + 0.2% of range)
50 kHz ≤ f < 100 kHz	±(0.6% of reading + 0.4% of range)
100 kHz ≤ f < 200 kHz	±(0.6% of reading + 0.4% of range)
200 kHz ≤ f < 400 kHz	±(1% of reading + 0.4% of range)
400 kHz ≤ f < 500 kHz	±(0.1 + 0.003 × f)% of reading + 0.4% of range)
500 kHz ≤ f < 1 MHz	±(0.1 + 0.003 × f)% of reading + 4% of range)
1 MHz ≤ f < 10 MHz	±(0.1 + 0.003 × f)% of reading + 4% of range)

\* Measurement bandwidth 20 MHz (-3 dB, Typical)

\* Accuracy over 1 MHz is design value

Power:	Direct (up to 5 A)	Frequency	Accuracy
			DC: ±(0.2% of reading + 0.4% of range) + 20 μA × U
		0.1 Hz ≤ f < 10 Hz	±(0.2% of reading + 0.2% of range)
		10 Hz ≤ f < 45 Hz	±(0.2% of reading + 0.1% of range)
		45 Hz ≤ f < 1 kHz	±(0.1% of reading + 0.1% of range)
		1 kHz ≤ f < 10 kHz	±(0.1% of reading + 0.16% of range)
		10 kHz ≤ f < 50 kHz	±(0.2% of reading + 0.2% of range)
		50 kHz ≤ f < 100 kHz	±(0.6% of reading + 0.4% of range)
		100 kHz ≤ f < 200 kHz	±(1.5% of reading + 0.6% of range)
		200 kHz ≤ f < 400 kHz	±(1.5% of reading + 0.6% of range)
		400 kHz ≤ f < 500 kHz	±(0.1 + 0.006 × f)% of reading + 0.6% of range)
		500 kHz ≤ f < 1 MHz	±(0.1 + 0.006 × f)% of reading + 6% of range)

Sensor Frequency	Accuracy
	DC: ±(0.2% of reading + 0.4% of range) + 50 μV × U
0.1 Hz ≤ f < 10 Hz	±(0.2% of reading + 0.2% of range)
10 Hz ≤ f < 45 Hz	±(0.2% of reading + 0.1% of range)
45 Hz ≤ f < 1 kHz	±(0.1% of reading + 0.1% of range)
1 kHz ≤ f < 10 kHz	±(0.1% of reading + 0.16% of range)
10 kHz ≤ f < 50 kHz	±(0.2% of reading + 0.2% of range)
50 kHz ≤ f < 100 kHz	±(0.6% of reading + 0.4% of range)
100 kHz ≤ f < 200 kHz	±(1.5% of reading + 0.6% of range)
200 kHz ≤ f < 400 kHz	±(1.5% of reading + 0.6% of range)
400 kHz ≤ f < 500 kHz	±(0.1 + 0.004 × f)% of reading + 0.6% of range)
500 kHz ≤ f < 1 MHz	±(0.1 + 0.004 × f)% of reading + 6% of range)

\* The unit of f in the equation for the reading error is (kHz).

\* These accuracies apply when the power factor = 1.

For the complete specifications, please refer to the separate document, Bulletin PX8000-02EN.

**General specifications**

Standard operating conditions	Ambient temperature: 23 ±5°C, Ambient humidity: 20 to 80%RH, Supply Voltage and frequency Within ±1% of rating, Altitude: 2000 m or less After the PX8000 has been warmed up for 30 minutes and then calibration has been performed.
Rated supply voltage	100 to 120 VAC / 220 to 240 VAC (Auto switching)
Rated supply frequency	50/60 Hz
Maximum power consumption	200 VA, 400 VA (installed /PD2 option)
Weight	Approx. 6.5 kg (weight of the PX8000 only without paper and /M2, /B5, /C20, /G5 and /P4 options) Approx. 7.5 kg (with /B5/C20/G5/M2/P4 and /PD2 options, without paper for printer)
Withstand voltage	1500 VAC for one minute between the power supply and case
Insulation resistance	10 M ohm or more for 500 VDC between the power supply and case

The voltage module (760811 (VOLTAGE)), current module (760812/760813 (CURRENT)), and AUX module (760851 (AUX)) uses laser light sources internally. These modules correspond to Class 1 laser product as defined in IEC60825-1:Safety of Laser Products-Part 1:Equipment Classification, and Requirements. In addition, this instrument complies with 21 CFR 1040.10 and 1040.11 except for deviations pursuant to Laser Notice No. 50, dated June 24, 2007.



Complies with 21 CFR 1040.10 and 1040.11 except for deviations pursuant to Laser Notice No.50, dated June 24, 2007  
 4-9-8 Myojin-cho, Hachioji-shi, Tokyo 192-8566, Japan

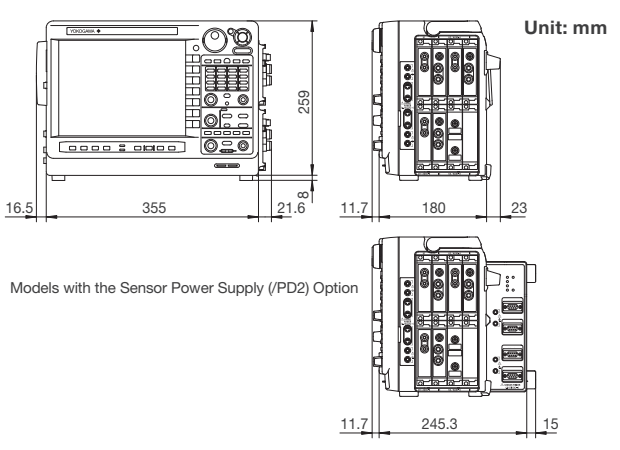



Model	Suffix Code	Description
PX8000		Precision Power Scope
Power Cord	-D	UL/CSA Standard
	-F	VDE standard
	-H	GB standard
	-N	NBR standard
	-Q	BS standard
	-R	AS standard
Languages	-HE	English menu
	-HG	German menu
	-HJ	Japanese menu
Options	/B5	Built-in printer (112 mm)
	/C20	IRIG function
	/G5	Harmonic measurement
	/M1	50 M memory expansion <sup>*1</sup>
	/M2	100 M memory expansion <sup>*1</sup>
	/P4	4 Outputs of probe power
	/PD2	4 Outputs of sensor power <sup>*2</sup>

\*1: Only one can be selected.

\*2: When use Shunt resistor Box for measurement, /PD2 option and Current module 760812 are required. The /PD2 option requires Firmware version Ver. 3.2 or later.

Name	Model	Description
Voltage Module	760811	Current module 760812 of 760813 must be ordered together
Current Module	760812	Voltage module 760811 must be ordered together
Current Module	760813	Voltage module 760811 must be ordered together
Auxiliary Module	760851	Auxiliary (AUX) module for sensor input, Torque/Speed

Name	Model	Description
PowerViewerPlus	760881	Viewer software dedicated for PX8000

- The German language menu will be released soon.
- Selection of both /M1 and /M2 is not available for one main frame. The standard memory length is 10 M points/CH.
- The power value will be calibrated using a pair of Voltage (760811) and Current (760812/760813) modules, therefore an equal quantity of these must be ordered together.
- A test Certificate of the Voltage Module includes the test results of the voltage and power values which are calibrated with one paired Current Module. Also the test Certificate of the Current Module includes the test results of the current and power values which are calibrated with one paired Voltage Module.

#### Standard Accessories;

Power cord (1 set), Front cover (1 set), Rubber foot (4 sets), Cover plate assy (8 sets), Current terminal adapter (4 sets), Voltage terminal adapter (4 sets), Printer chart (1 set for /B5), Getting started guide (1 set), CD (Getting started guide, Futures guide, User's Manual, Communication interface manual by PDF data)

#### Yokogawa's approach to preserving the global environment







- Yokogawa's electrical products are developed and produced in facilities that have received ISO14001 approval.
- In order to protect the global environment, Yokogawa's electrical products are designed in accordance with Yokogawa's Environmentally Friendly Product Design Guidelines and Product Design Assessment Criteria.

#### Notice

- Before operating the product, read the user's manual thoroughly for proper and safe operation.
- If this product is for use with a system requiring safeguards that directly involve personnel safety, please contact the Yokogawa offices.

This is a Class A instrument based on Emission standards EN61326-1 and EN55011, and is designed for an industrial environment. Operation of this equipment in a residential area may cause radio interference, in which case users will be responsible for any interference which they cause.

Any company's names and product names mentioned in this document are trade names, trademarks or registered trademarks of their respective companies. The User's Manuals of this product are provided by CD-ROM.

Model number	Product	Description
366924	 BNC-BNC Cable	1 m
366925	 BNC-BNC Cable	2 m
366926	 1:1 BNC-Alligator Cable	Non-isolated 42 V or less 1 m
366961	 1:1 Banana-Alligator Cable	Non-isolated 42 V or less 1.2 m
700924	Differential Probe	1400 Vpk, 1000 Vrms-CAT II
700929	10:1 Probe (for isolation BNC input)	1000 V (DC+ACpeak) CAT I
701901	1:1 Safety BNC Adapter Lead (in combination with followings)	1000 Vrms-CAT II
701902	Safety BNC-BNC Cable (1 m)	1000 Vrms-CAT II (BNC-BNC)
701903	Safety BNC-BNC Cable (2 m)	1000 Vrms-CAT II (BNC-BNC)
701906	Long Test Clip	For 700924 and 701926
701926	Differential Probe	Maximum 7000 Vpk, 5000 Vrms
701947	100:1 Isolation Probe	1000 V (DC+ACpeak) CAT I
701948	Plug-On Clip	For 700929 and 701947
701954	Large Alligator-Clip (Dolphin type)	1000 Vrms-CAT II, 1 set each of red and black
701959	Safety Mini-Clip (Hook type)	1000 Vrms-CAT II, 1 set each of red and black
701963	Soft Carrying Case	For PX8000
720911	External I/O Cable	For external I/O connection
758917	Test Lead Set	A set of 0.8 m long, red and black test leads
758921	 Fork Terminal Adapter	Banana-fork adapter, Two adapters to a set
758922	 Small Alligator-clip	Rated at 300 V and used in a pair
758923	Safety Terminal Adapter	(spring-hold type) Two adapters to a set
758929	 Large Alligator-clip	Rated at 1000 V and used in a pair
761952	Safety Terminal Conversion Adapter Set	Two adapters to a set for 5 A current (female-female type)
761953	Safety Terminal Adapter Set	Two adapters to a set for 5 A current (screw-fastened type using B9317WD)
CT60	AC/DC Current Sensor	Maximum 60 Apk, DC to 800 kHz (-3 dB)
CT200	AC/DC Current Sensor	Maximum 200 Apk, DC to 500 kHz (-3 dB)
CT1000	AC/DC Current Sensor	Maximum 1000 Apk, DC to 300 kHz (-3 dB)
CT2000A	AC/DC Current Sensor	Maximum 2000 Arms, DC to 40 kHz (-3 dB)

Parts number	Product	Description	Order Q'ty
A1323EZ	Shunt Resistor Box	5 Ω ±0.05%	1
A1324EZ	Shunt Resistor Box	10 Ω ±0.02%	1
A1325EZ	Shunt Resistor Box	20 Ω ±0.02%	1
A1559WL	Current sensor cable	Cable length 3 m for Shunt Resistor Box	1
A1560WL	Current sensor cable	Cable length 5 m for Shunt Resistor Box	1
A1589WL	Current Sensor Direct Cable	Cable length 3 m (Burden resistor 2.7 Ω)	1
A1628WL	Current Sensor Direct Cable	Cable length 5 m (Without Burden resistor)	1
B8213ZA	Safety Terminal Adapter	(screw-fastened type) Two adapters to a set for current	4
B8213ZD	Safety Terminal Adapter	(screw-fastened type) Two adapters to a set for voltage	4
B9284LK	 External Sensor Cable	Current sensor input connector, Length 0.5 m	1
B9317WD	Wrench	For B8213ZD and B8213ZA	1
B9988AE	Printer Roll Paper	For PX8000, 10 m x 10	1

 Due to the nature of this product, it is possible to touch its mental parts. Therefore, there is a risk of electric shock, so the product must be used with caution.

\*1: Use these products with low-voltage circuits (42 V or less).

**isoPRO** is trademark of Yokogawa Electric Corporation.



For the full specifications see Bulletin PX8000-02EN or [tmi.yokogawa.com/px8000](http://tmi.yokogawa.com/px8000)

# YOKOGAWA

YOKOGAWA TEST & MEASUREMENT CORPORATION

Global Sales Dept. /E-mail: [tm@cs.jp.yokogawa.com](mailto:tm@cs.jp.yokogawa.com)

YOKOGAWA CORPORATION OF AMERICA

YOKOGAWA EUROPE B.V.

YOKOGAWA TEST & MEASUREMENT (SHANGHAI) CO., LTD.

YOKOGAWA ELECTRIC KOREA CO., LTD.

YOKOGAWA ENGINEERING ASIA PTE. LTD.

YOKOGAWA INDIA LTD.

YOKOGAWA ELECTRIC CIS LTD.

YOKOGAWA AMERICA DO SUL LTDA.

YOKOGAWA MIDDLE EAST & AFRICA B.S.C(c)

<http://tmi.yokogawa.com/us/>

<http://tmi.yokogawa.com/eu/>

<http://tmi.yokogawa.com/cn/>

<http://tmi.yokogawa.com/kr/>

<http://tmi.yokogawa.com/sg/>

<http://tmi.yokogawa.com/in/>

<http://tmi.yokogawa.com/ru/>

<http://tmi.yokogawa.com/br/>

<http://tmi.yokogawa.com/bh/>

<https://tmi.yokogawa.com/>

YMI-N-MI-M-E03

The contents are as of May 2013. Subject to change without notice.  
Copyright © 2014, Yokogawa Test & Measurement Corporation  
[Ed: 06/b] Printed in Japan, 305(KP)