

Fast transient burst simulator

FNS-AX4 series



Fast transient / burst simulator

FNS-AX4-A20/B63

Feature

- IEC 61000-4-4 Ed.3 standard compliance.
- Pre-check function is installed. Inspection before testing is now easy.
- Normal mode test support. Taking account of field troubles is possible. (option)
- Utilize a tri-color pilot light to carry out safer test. (option)
- Utilize an outlet box that simplifies EUT connection. (option)
- Compared with conventional products, the size has become compact. (Approximately 67% by volume)
- Easy to understand Panel display reduces mistakes in connecting power cables.
- Software control with Android™ and Windows. (option)
- Next calibration date can be notified. (Android / Windows software only)
- Employ LCD screen with multi-language support and enhanced operability.
- Maximum output voltage of 5 kV and maximum pulse frequency of 2 MHz allow you to test above the standard test level.
- CDN capacity is increased to single phase type AC 240V 20A, single and three phase type to AC 600 V 63 A, supporting wider range of EUT.
- Large capacity CDN (100A or 150A) option available for Injection test on various EUT
- Using coupling clamps, EMS probe kits, you can test the signal lines and evaluate the noise immunity on the PCB. (option)
- Easy-to-understand help function. (Android / Windows software only)



FNS-AX4-A20



FNS-AX4-B63

Specification

■ Generator specification

Item	Specification / Function
Output voltage	200 to 5000 V 10 V Step
Polarity	Positive or negative, polarity alternation possible per burst
Repetition frequency	0.1 kHz to 2000 kHz 0.1 kHz to 1 kHz / 0.01 kHz step Tolerance ± 5%, 1.0 kHz to 10 kHz / 0.1 kHz step Tolerance ± 5% 10 kHz to 100 kHz / 1 kHz step Tolerance ± 5%, 100 kHz to 1000 kHz / 10 kHz step Tolerance ± 5% 1000 kHz to 2000 kHz / 100 kHz step Tolerance ± 10%, (Limitation per voltage levels when continuous output)
Number of pulses	1 to 1000 at a step of 1 pulse, Setting limit: 1 pulse per ms in a burst (repetition frequency 1 kHz or more)
Burst duration	Formula for Burst duration = Pulse number / Repetition Frequency Scope of manually setting value for burst duration: 0.01 to 999 ms
Burst period	10 to 1000ms ± 10% 10ms steps (500ms or more for polarity alternate mode)
Polarity alternate function	Output polarity alternated between positive and negative at each burst period Setting condition: the burst period is 500ms or more and the burst pause period [(burst period) - (burst duration)] is 100ms or more Maximum test time: 10 minutes
Continuous Pulse output	Up to 1000 V-10kHz or less, to 2000V-4kHz or less, to 5000V-1kHz or less. Maximum test time for each case: 10 min
Frequency modulation	Frequency is shifted continuously between set frequency and approximately -10% from the set frequency. The modulating wave is triangular wave of approximately 20Hz
External trigger	External trigger input invokes 1 burst output in synchronization with the trigger input. Trigger specification: Hi (+ 5V) → Lo (0 V) triggers one burst period.
Pulse waveform (at 50 Ω load)	Pulse peak voltage: (set voltage / 2) ± 10% Rise time: 5 ns ± 30% Pulse width: 50 ns ± 30%
Pulse waveform (at 1 kΩ load)	Pulse peak voltage: (set voltage × 0.95) ± 20% Rise time: 5 ns ± 30% Pulse width: 35 to 150 ns
DC blocking capacitor	10nF ± 20%

■ CDN specification

Item	Specification / Function
Power capacity	A 20 model: Single phase AC 240 V / 20 A, DC 125 V / 20 A (10 A for PE) B 63 model: three-phase AC 600 V / 63 A, DC 125 V / 63 A (10 A for N/PE)
Applied phase	A20 model: L / N / PE B63 model: L1 / L2 / L3 / N / PE Single line or all lines can be specified individually for each phase
Injection mode	Common mode (Normal mode available using option)
EUT Line input/output	φ6 mm safety socket
Coupling capacitor	33 nF
Output waveform specification	Pulse peak voltage: (set voltage) / 2 ± 10% Rise time: 5.5 ns ± 1.5 ns Pulse width: 45 ns ± 15 ns Set voltage ± 4000 V, frequency specified from 5 kHz to 100 kHz
Input residual voltage	10% or less of setting pulse voltage EUT line input is 50 Ω termination, line output is defined as open
AC Line Sync	Synchronous and asynchronous setting available. Setting phase angle: 0 to 360° ± 10° 1° Step Synchronizable voltage: AC 85 V to rated voltage Reference phase: between L-N (A20 model), L1-L2 (B63 model)

■ Other specifications

Item	Specification / Function
emergency stop	Push lock type switch (Test stop, EUT line OFF)
EUT FAIL function	FAIL signal from external (Hi → Lo) detected during test FAIL signal specifications VLO: 0 V, VHI: +5V Choose operation from test stop/pause when triggered 3 channels available for the FAIL input
External interface	REMOTE (For external PC control), CDN I/F (For external CDN), INDICATOR (For Warning Lamp or indicator lamp) EUT FAIL INPUT (For temporary pause at EUT failure event)
Accessory	Power Cable, SG Cable, Line Input Cable, Output Cable, Waveform Check Connector, Coaxial Cable, Operation Manual, Accessory bag
Operating environment	Temperature 15 to 35 ° C Relative humidity 25 to 75%
External dimension / Weight	W430 × H199 × D370 mm (excluding protrusions) / Approximately 14 kg (A20 model) and 22 kg (B63 model)
Power supply	AC100 to 240V ± 10% 50/60 Hz Approximately 120 VA

Operation Screen

■ Operation Screen

In each test mode screen, you can simply push button on/off and simply enter numerical parameters with the numeric keypad. In addition, all test conditions can be set within 1 to 2 screens deep.

STANDARD mode

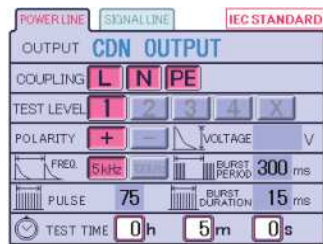

The test conditions defined in IEC 61000-4 are pre-set. When injected on the power supply, test pulse frequencies are 5 kHz or 100 kHz and voltage selections are 0.5 kV, 1.0 kV, 2.0 kV, 4.0 kV.

MANUAL mode

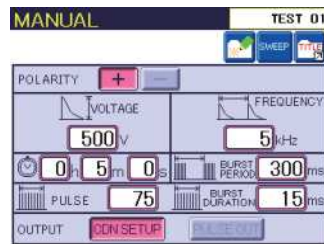

In the MANUAL mode, detailed test conditions can be set. The pictograms are shown to intuitively understand the setting of the test conditions. From this screen you can switch to the setting screen for conducting the sweep test.

MANUAL mode (Test condition setting)

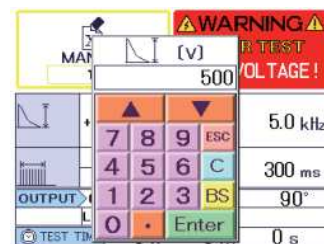

Polarity and injection phase setting can be easily set by turning the button on/off. Numerical parameters, such as test voltage, etc. can be entered with numeric keypad which appears when necessary for easy number entering.

MANUAL mode (sweep test setting)

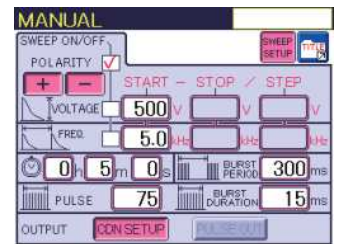

It is a test mode in which the condition of output voltage and repetition frequency change can be set to be executed automatically. In the setting example, shows burst voltage change in 100V step from 500V to 1000V. A convenient function for judging the malfunction point of EUT by setting the condition change of output voltage, repetition frequency, polarity, power injection phase, injection phase angle.

■ Screen Configuration

Set either "STANDARD" or "MANUAL" from the menu screen, and make various settings such as test voltage, polarity, frequency, injection phase and so on. "MANUAL" also allows you to set the sweep mode injection. You can store up to 30 test conditions. In "SEQUENCE", you can call up the test conditions set in "MANUAL" and combine the test conditions of maximum 18 steps, and create up to 15 programs. You can also pre-check before starting test.

● Easy setting for Standard test

The setting is only selection from the preset levels for IEC standard testing

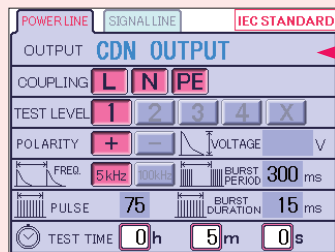

● Easy operation from main menu

Intended test or settings are easily selectable at main menu

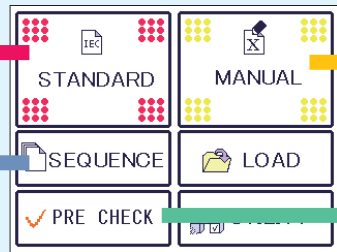

● Detailed test setting operation is also easy

Various conditions like voltage, frequency, injection phase can be set in MANUAL mode and saved.

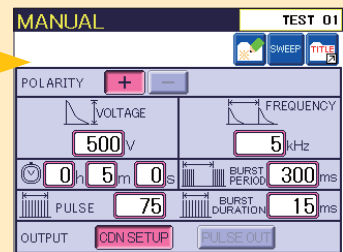

● Easy to understand the test process

Test conditions in process are easily monitored

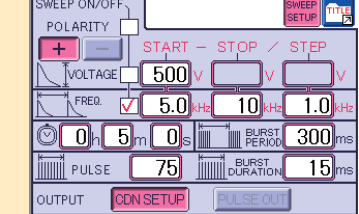
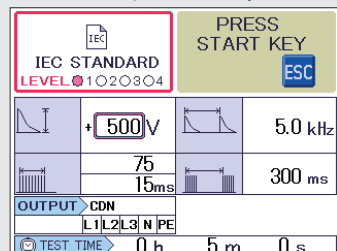

● Easy setting for sequence test

Restore test conditions set in MANUAL and perform them sequentially

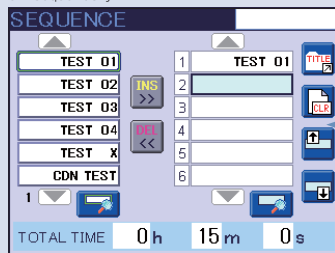

● Pre-check function installed

Connection of check port is shown. Push Start switch to perform pre-check for PASS/FAIL check result.

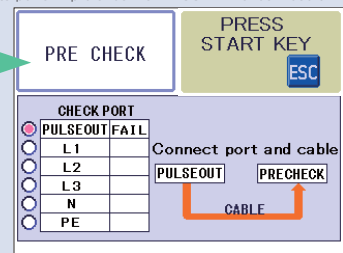

FNS-AX4-A20/B63

Feature

Easy to perform pre-test inspection with pre-check function

In the inspection prior to the test, a dedicated attenuator and an oscilloscope were required for waveform output check. Now FNS-AX4 has a built-in monitor circuit, makes it easy to perform pre-check inspection before testing by just connecting the waveform observation connector with the attached coaxial cable.



Coupling Balun ready for normal mode test

IEC 61000-4-4 standard has the provision of the common mode test only, but noise may enter the equipment in the normal mode in the field and malfunction may occur. ANSI C37.90.1 standard specifies for corresponding normal mode noise testing. FNS-AX4 can now perform the normal mode test complying with ANSI C 37.90.1 standard with an optional dedicated normal mode coupling balun.



Simple and Easy EUT power line connection Injection phase indicator on front panel

In order to prevent mistakes in the connection of the power cable during the test, Front panel shows the connection destination at a glance. Also an outlet box (option) is available for the simple power connection.



Easy to understand test settings in "multi-language"

In addition to Japanese, operation in English, Korean, and Chinese are provided for easy understanding of the test setting and operation.



Remote control Software is available

Android application in addition to Windows software is available for customer environment for setting test conditions, saving test results, recording test logs, report generation, etc. .

for Windows



for Android



OUTPUT Waveform

PULSE OUT connector waveform: 50Ω

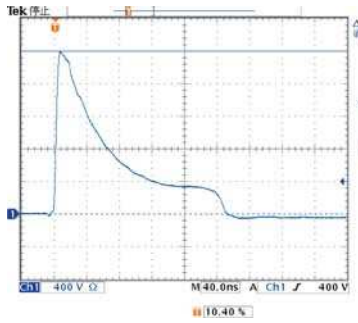

EUT LINE OUTPUT waveform : 50Ω

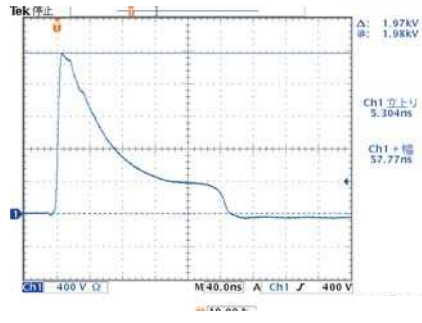

Repetitive pulses output as burst

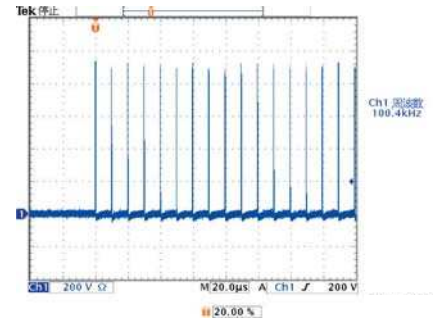

Front Panel / Rear Panel

Front Panel

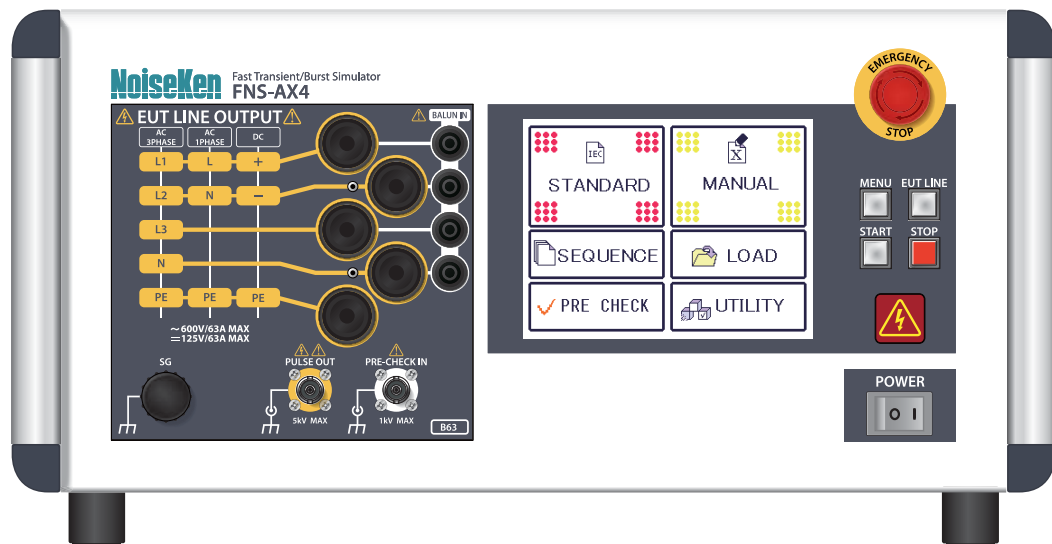

Rear Panel

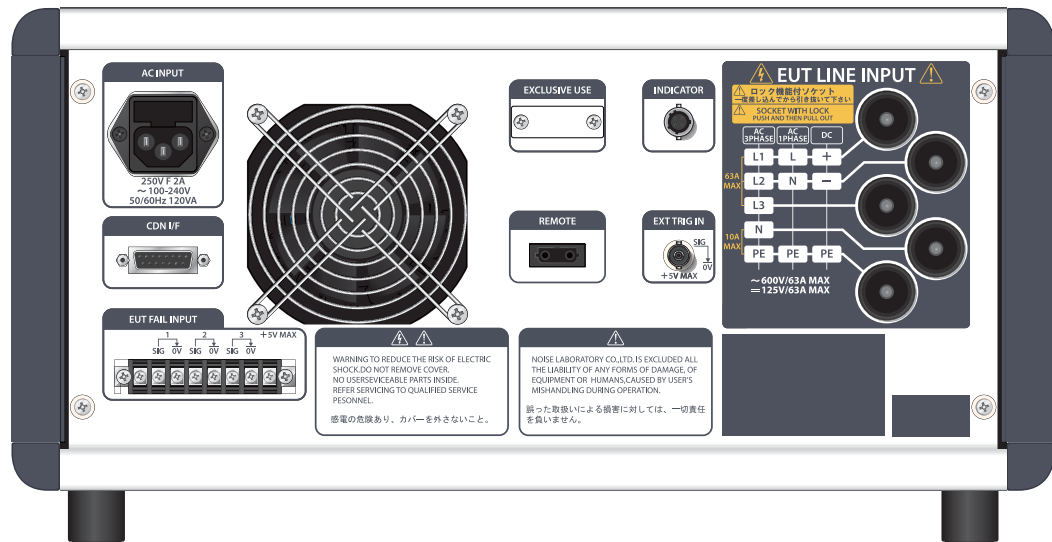

FNS-AX4-A20/B63

Windows software

Remote control from Windows PC is possible using optional Optical USB module (MODEL : 07-00022A)



Test Log

Manual Test/ Sequential test will create test log and setting file and saved automatically. Setting file is named automatically from the tested year/month/date/time.

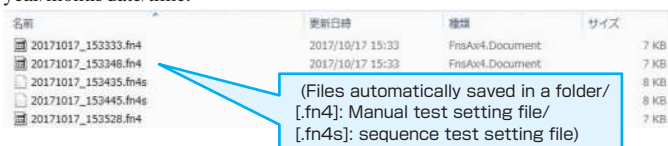

With software setting, you can enable or disable test log saving and also set folder location of the setting files saved. You can restore the testing condition saved in the test log to re-test with the previously saved condition.

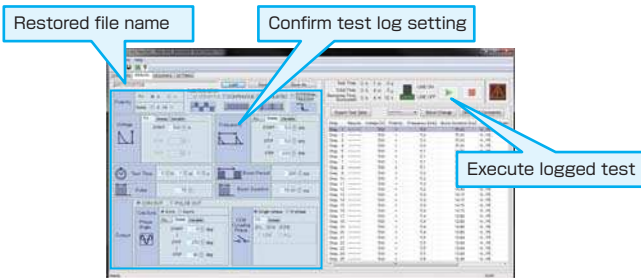

Standard mode test screen (For IEC standard testing)

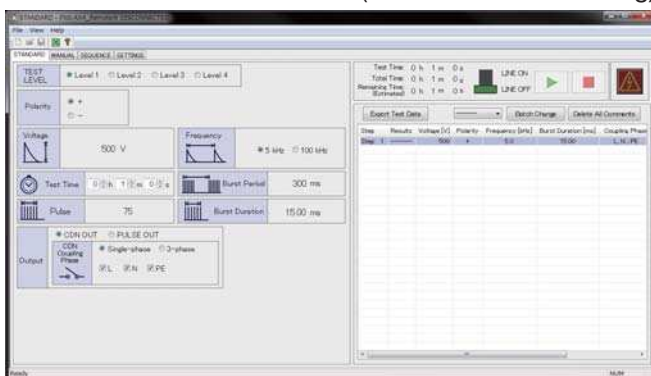

Sequence mode test screen (For sequence test)

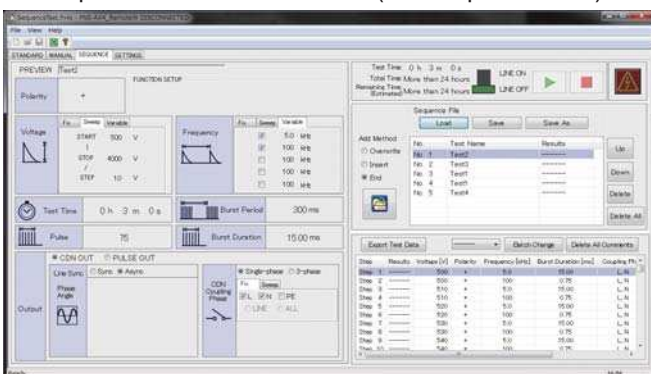

Next calibration date notification

Following notification will be shown when it is the date set as notified date. It is simply set by the pop-up calendar

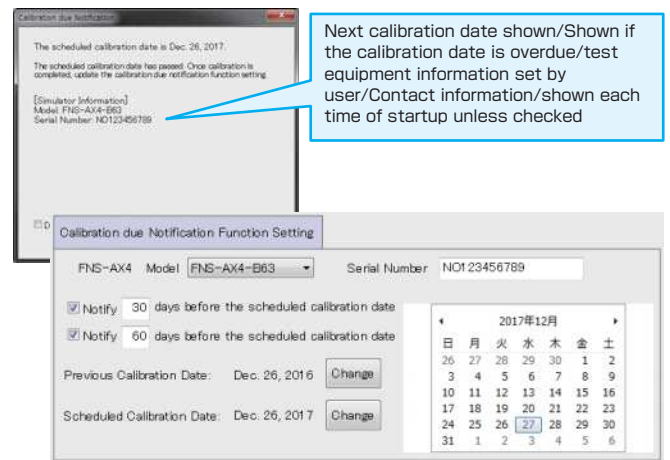

Manual mode test screen (For Manual setting)

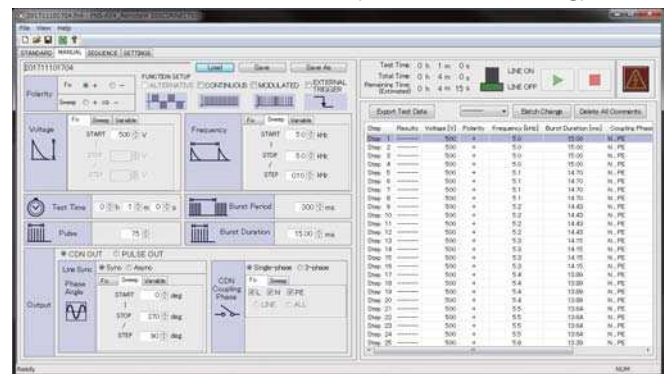

In Manual mode, A balloon show up to indicate setting limitation by just placing mouse pointer. Balloon display can be enabled or disabled.

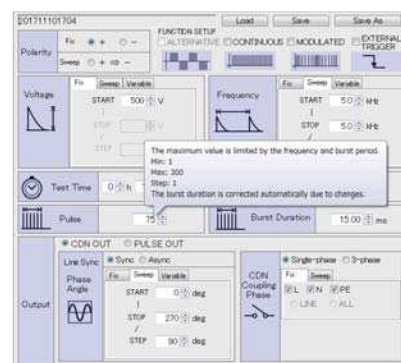

FNS-AX4-A20/B63

Android Application

Remote control from Android tablet is possible using Optical Interface box and Bluetooth RS-232C conversion adapter.



Test Log

Test will save test log as DATA LIST and can be restored for re-testing with the saved condition

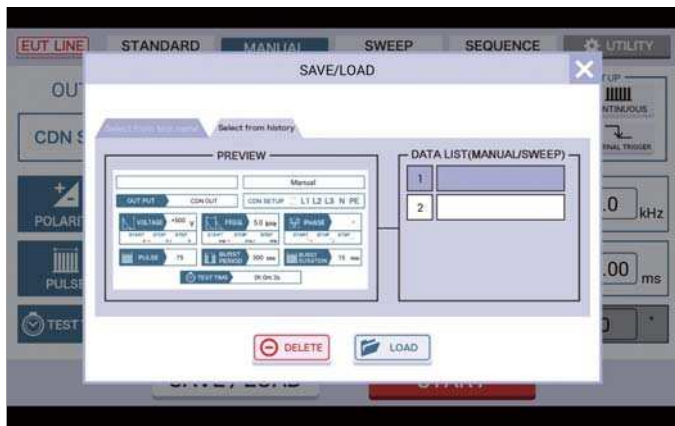
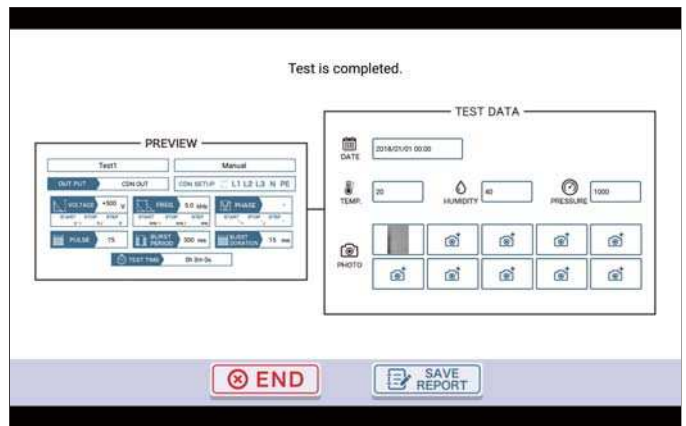
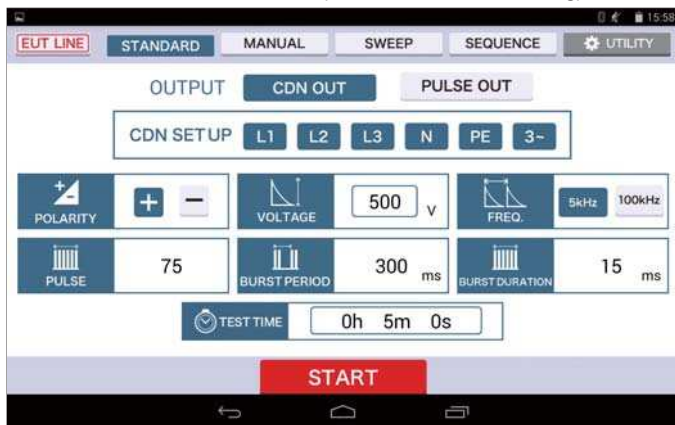

Photo shot

You can take a photo shot of the actual test situation and save it as test log. It simplifies generating reports



Standard mode test screen (For IEC standard testing)



Manual mode test screen (For Manual setting)

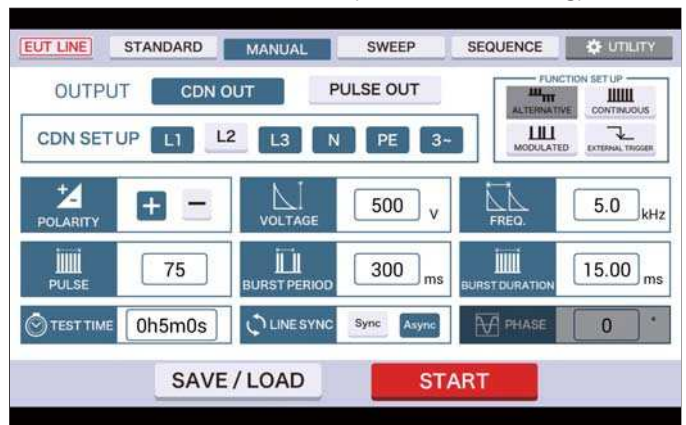

Sweep mode test screen (For sweep test)

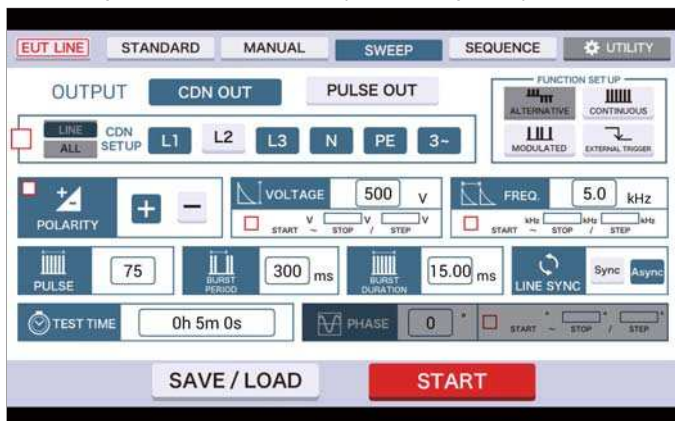

Sequence mode test screen (For sequence test)

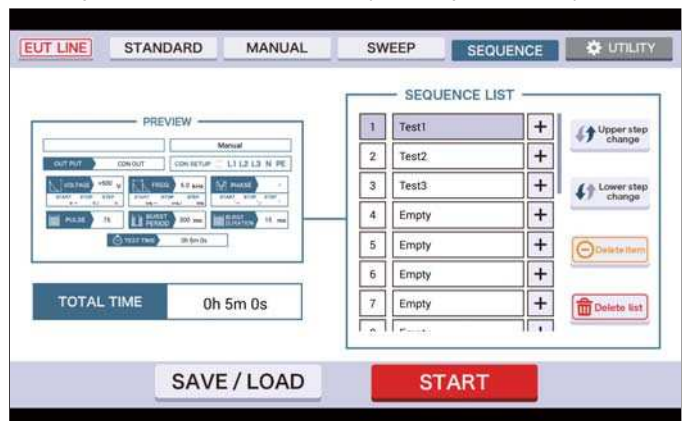

※ Only Noiseken specified Android tablet is compatible with our Android application.

Option

Coupling Clamp MODEL: 15-00012A



Clamp calibration fixture (15-00010A)



Coupling clamp for capacitive coupling test on interconnection lines complying IEC61000-4-4 Ed.3. In addition, calibration fixture for coupling clamp is available.

- Size: W1110 x D210 x H189 mm (Excluding protrusion)
- Visibility of the tested cable is improved by the transparent plastic upper lid
- Clamp bar allows you to easily fix coupling plate to the signal line or control lines

Normal mode coupling balun Model: 15-00013A



The product allows injection of test voltage on EUT with Normal mode. 5kV Max.

Outlet box MODEL : 18-00081A



OUTLET BOX converts LINE output socket. Outlet type: B type (3P, JP/USA type) AC125V 15A MAX
※ Consult with us for other type of outlet box

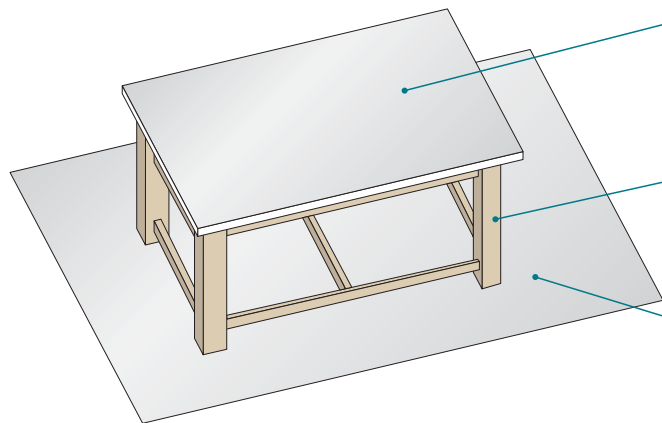

Horizontal coupling plate MODEL : 03-00020A

Metal plate placed on the table for the testing of tabletop EUT. W1600×D800×t1.5mm×1 sheet (Made of Aluminum)
※ Used as a horizontal coupling plate in ESD testing and also can be used as a ground plane

Test table MODEL : 03-00039A

Wooden table used for table top EUT testing. W1600 × H800 × D800mm

Ground plane MODEL : 03-00007A

Ground plane used for testing large floor standing EUT. W1800 × D1000 × t1.5mm × 3 sheets(Made of aluminum)

Insulating block MODEL : 03-00054A

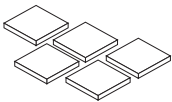

Keep the EUT and its wirings afloat above the ground plane
Size: W300x D300 x H50 mm
Material: foamed polyethylene
5 pcs per set

Insulating support MODEL : 03-00024A

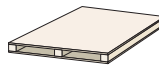

Keep the EUT and its wirings 10cm afloat above the ground plane
Size: W1200x D1200 x H100 mm
Material: Wood
Weight withstand: 500kg

Cubic insulator block MODEL : 03-00029A

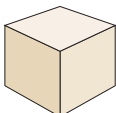

Keep the EUT and its wirings 10cm afloat above the ground plane
Size: W100x D100 x H100 mm
Material: Wood
4 pcs per set

SG cable MODEL : 05-00103A



Braided wire cable to connect between SG terminal of the main unit and the ground reference plane.
Length: 0.1m

Warning Lamp MODEL : 11-00008A



Alarm lamp for FNS-AX4 series. Alarm lamp illuminated when high voltage is generated at the time of test

Tri-color pilot light MODEL : 11-00015A



The light is for FNS-AX4 series. Three colors indicate corresponding simulator's test status change.

Option

Attenuator for waveform check MODEL : 00-00017A

Attenuator for measuring high voltage pulse.



Parameter	Specification
Attenuation rate	DC~2GHz : 40dB (100 : 1)
Input pulse peak voltage	4000V MAX
Tolerable continuous pulse examples	Repetition Frequency : ≤5 kHz Burst duration : ≤15 ms Burst period : ≥300 ms. (Assuming IEC 61000-4-4 pulse waves)
Input impedance	50Ω (50Ω ± 1% at DC)
Output impedance	50Ω (50Ω ± 1% at DC)
Interface connectors	INPUT : HN(F) OUTPUT : N(F)
Dimension/ Weight	W154.5mm×D105mm×H37mm Approximately 1350g

Attenuator for waveform check MODEL : 00-00018A

Attenuator for measuring high voltage pulse.



Parameter	Specification
Attenuation ratio	DC~400 MHz : 60 dB (1000 : 1)
Input pulse peak voltage	5000V MAX
Tolerable continuous pulse examples	Repetition frequency : ≤5 kHz Burst duration : ≤15 ms Burst period : ≥300 ms. (Assuming IEC 61000-4-4 pulse waves)
Input impedance	1000Ω ± 2%
Output impedance	50Ω (±2% at DC~400MHz)
Interface connectors	INPUT : NMHV(F) OUTPUT : N(F)
Dimension / Weight	W133mm×D25.4mm×H25.4mm Approximately 150g

OPTICAL INTERFACE BOX MODEL : 07-00028A

Required for FNS to be control by Android tablet.
*Bluetooth RS-232C conversion adapter is required in addition to this option.

Optical USB module MODEL : 07-00022A



Conversion adapter to interface with PC for the remote control of FNS
USB to optical interface. Fiber cable 5m included.

EMS Probes Kit MODEL: H2-B



Probes kit to enable the noise injection onto PCB patterns, flat cables, etc. The probes can be selectable for either electric fields or magnetic fields in order to irradiate in the near field.

- Choose noise radiation points at will on PCB or harness.
- Inject noise either electrically or magnetically by choosing probes.
- Provides 3 each pieces of electric field probe or magnetic field probe in different form and size.
- Weak noise tolerance points can be found with granularity of mm of injection scope.

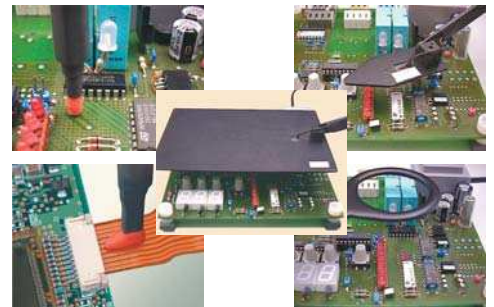
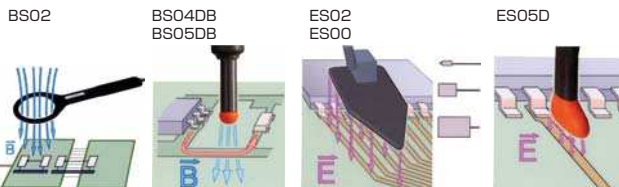

Noise Injection Probe MODEL: 01-00034A



- Direct noise injection on a LSI pin makes the board level noise tolerance testing possible.
 - Maximum injection voltage up to 500V.
 - Optional coupling capacitor available (Option)
- [Option]
Coupling capacitors: 06-00039A: 220pF 06-00040A: 330pF 06-00041A: 3pF 06-00042A: 500pF

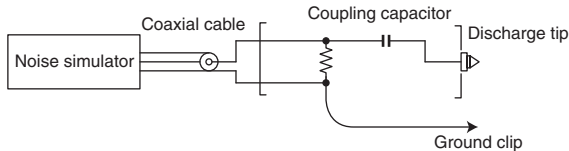

Radiation Probes MODEL: 01-00006A / 7A / 8A / 9A / 10A / 31A / 50A



Probes with which irradiate the noise at wiring on PCB of electronic equipment. Weak noise tolerance points can be detected using the probe.

Parameter	Specification
Input voltage	4000V Max
Input pulse width	50ns~1 μs
Loop diameter	06A: φ50mm, 07A: φ75mm, 08A: φ100mm, 09A: φ150mm, 10A: φ200mm, 31A: φ250mm, 50A: φ30mm
Cable length	Approx. 2m
Weight	Approx. 180g-220g
Termination resistor	Not contained

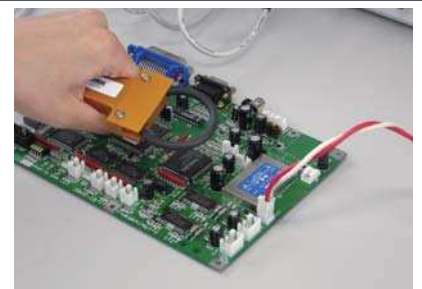

Option

Coupling Adapter MODEL: CA 805B



CA-805B makes testing for noise tolerance possible by just clamping interconnection cable of electrical equipment in combination with FNS series.

- Inject noise without cutting cables
- Able to test individual noise tolerance of electrical equipment
- Able to clamp bundle lines up to 26 mm max diameter

Parameter	Specification
Input voltage	4000V Max
Dimension	(W) 350 X (H) 120 X (D) 130mm
Clamp interim	26mm
Weight	Approx. 3kg

Coupling Adaptor MODEL: 15-00007A (CA 806)



15-00007A (CA-806) makes testing for noise tolerance possible by just clamping interconnection cable of electrical equipment in combination with FNS series.

- Inject noise without cutting cables
- Able to test individual noise tolerance of electrical equipment
- Able to clamp bundle lines up to 27 mm max diameter

Parameter Structure	Specification
Input voltage	2000V Max.
Coupling ratio	1/10 of input voltage $\pm 10\%$
Termination resistance	50 Ω system built-in
Max. diameter of cable clamped	27mm
Dimension	(W) 89 X (H) 64 X (D) 120mm (excluding protrusion)
Weight	Approx. 1000g

Coupling adapter MODEL : CA-803A



CA-803A makes testing for noise tolerance possible by just clamping interconnection cable of electrical equipment in combination with FNS series.

- Inject noise without cutting cables
- Able to test individual noise tolerance of electrical equipment
- Able to clamp bundle lines up to 15 mm max diameter

Parameter	Specification
Input voltage	2000V Max
Coupling ratio	1/20 of input voltage $\pm 10\%$
Dimension	(W) 160 X (H) 60 X (D) 35mm
Mass	Approx. 400g

<Quick comparison of Clamps>

Clamp Model	Coupling method	Maximum Input voltage	Coupling ratio	Interim diameter of clamp
CA-805B	Capacitive (Electrostatic)	$\pm 4000V$	1:1	26mm
CA-803A	Inductive (Magnetic)	$\pm 2000V$	20:1	15mm
CA-806	Inductive (Magnetic)	$\pm 2000V$	10:1	27mm

High power Coupling Decoupling Network

High powered Coupling Decoupling Network (CDN) can be provided for customers' requirements. Please consult with us for details.



Coupling Fixture for High Frequency Surge Test

Coupling fixture provided to inject noise to harness in combination with Fast Transient Burst simulator. The varieties of coupling capacity are lined up. Please contact us for details.



IEC61000-4-4 Ed.3 Test Standard

1. General

The Test Standard for evaluating immunity of electric / electronic equipment when they are interfered by fast transient repetitive bursts which are generated by break of inductive load equipment or bounds of relay contact point.

2. Test Level

Open circuit output test voltage and repetition rate of the impulses

Level	On power port, PE		On I/O (input/output) signal, data and control ports	
	Voltage peak (kV)	Repetition rate (kHz)	Voltage peak (kV)	Repetition rate (kHz)
1	0.5	5 or 100	0.25	5 or 100
2	1	5 or 100	0.5	5 or 100
3	2	5 or 100	1	5 or 100
4	4	5 or 100	2	5 or 100
X	Special	Special	Special	Special

3. Burst Generator and Waveform Verification

Circuit diagram of a fast transient/burst generator

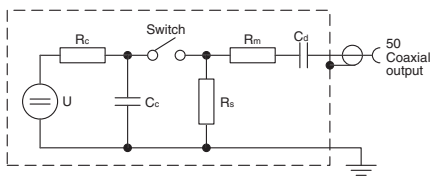

- U High-voltage source
- Rc Charging resistor
- Cc Energy storage capacitor
- Rs Impulse duration shaping resistor
- Rm Impedance matching resistor
- Cd DC blocking capacitor

Waveshape of a single pulse into a 50 Ω load

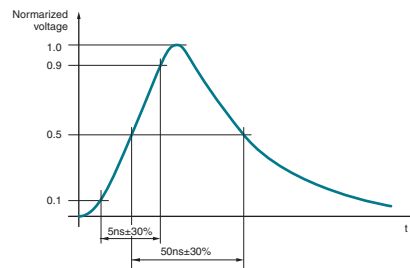

Waveshape of a single pulse into a 1kΩ load

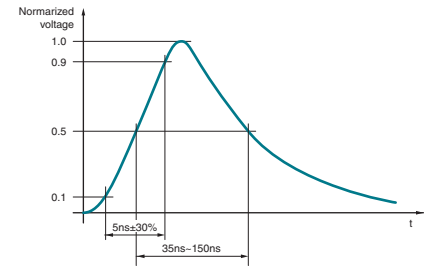

Pulse wave shape into a 50 Ω load and general graph of a fast transient/burst

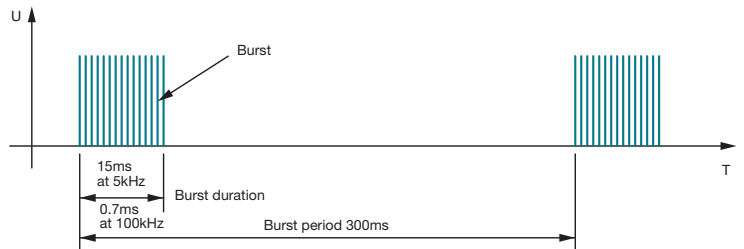
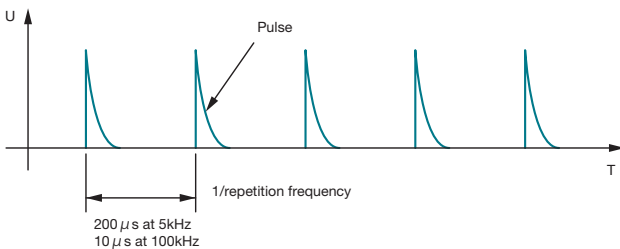

■ CDN for AC/DC power mains supply ports/terminals

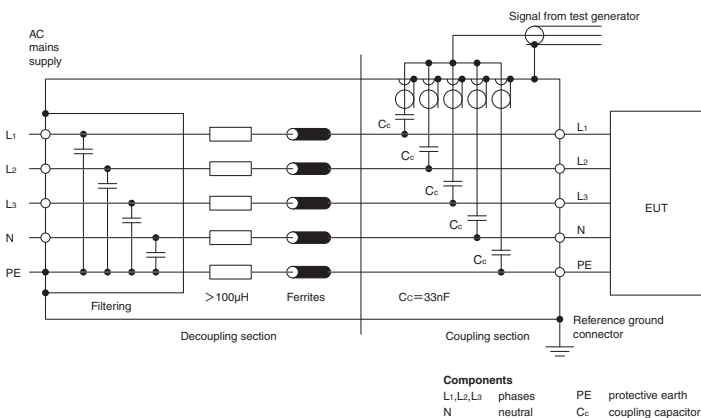

■ Capacitive couplin clamp

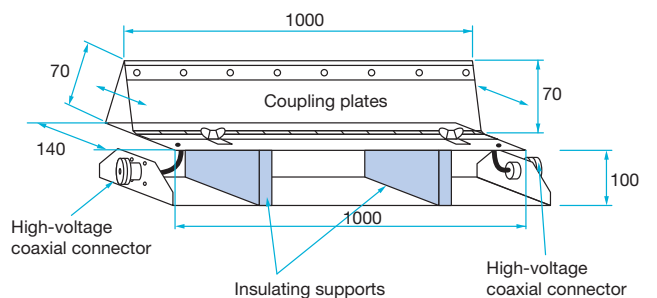

IEC61000-4-4 Ed.3 Test Standard

■ Waveform Verification on 50Ω load (In case of using waveform verification attenuator 00-00017A)

① Connect between input of waveform verification attenuator 00-00017A and PULSE OUT of the test equipment using coaxial cable comes with the attenuator (HN(P)-NMHV(P)).

Also connect between oscilloscope input and output connector of the attenuator using coaxial cable comes with the test equipment (N(P)-BNC(P)).

Add an attenuator to oscilloscope if necessary.

② Input impedance of oscilloscope shall be set to 50 ohm because output impedance of 00-00017A is 50 ohm.

③ START the test equipment generator.

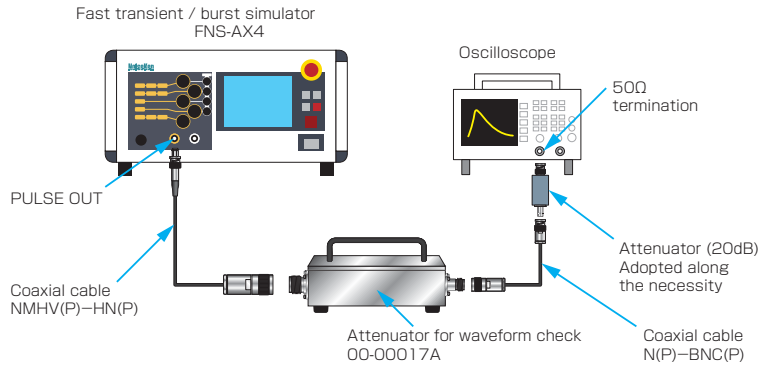

■ Waveform Verification on 1kΩ load (In case of using Waveform verification attenuator 00-00018A)

① Directly connect the input of waveform verification attenuator 00-00018A and PULSE OUT of the test equipment.

Also connect between oscilloscope input and output connector of the attenuator using coaxial cable comes with the test equipment (N(P)-BNC(P)).

Add an attenuator to the oscilloscope if necessary.

② Input impedance of oscilloscope shall be set to 50 ohm because output impedance of 00-00017A is 50 ohm.

③ START the test equipment generator.

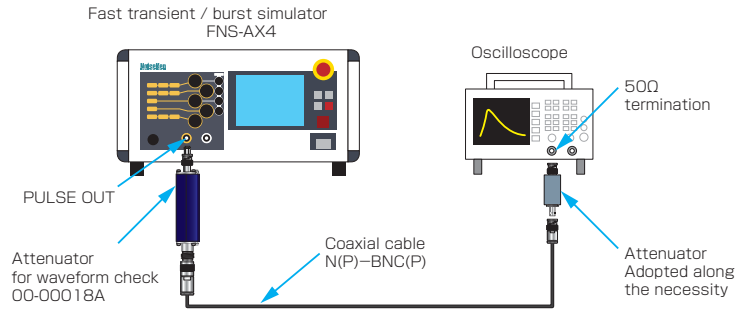

■ Waveform verification at EUT LINE OUT (using 02-00152A and 00-00017A)

① Use a waveform verification connector(02-00152A) in the accessory onto EUT LINE OUTPUT and ground reference socket.

② Set the simulator to inject all phases and verify waveform of each OUTPUT LINE.

③ Insert the waveform verification connector straight onto EUT LINE OUTPUT connector and ground reference socket next to the connector. Be sure to insert deep and secure.

④ Connect between input connectors of waveform verification attenuator 00-00017A and the waveform verification adapter using coaxial cable comes with the attenuator (HN(P)-NMHV(P)).

Also connect between oscilloscope input and output connector of the attenuator using coaxial cable comes with the test equipment (N(P)-BNC(P)).

Add an attenuator to the oscilloscope if necessary.

⑤ Input impedance of oscilloscope shall be set to 50 ohm because output impedance of 00-00017A is 50 ohm.

⑥ START the test equipment generator.



02-00152A adapter mounted onto L2(N-) port of EUT LINE OUTPUT

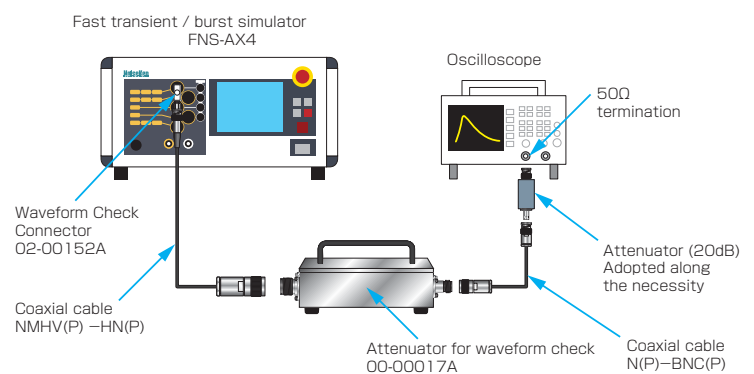
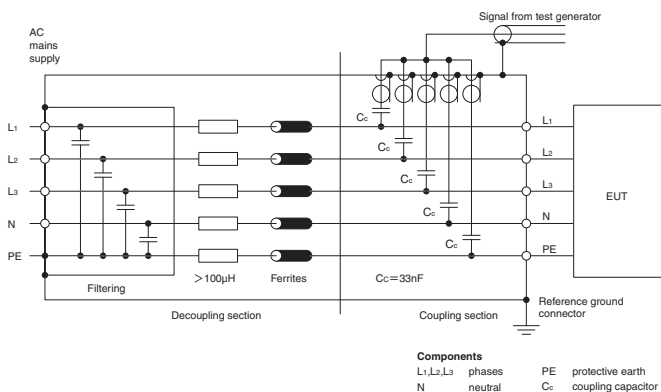

IEC61000-4-4 Ed.3 Test Standard

4. Test Setup

■ Test Method to Power Supply Lines

- ① Put the simulator onto ground reference plane which is connected to the protective ground and connect SG terminal on the front panel to the ground reference plane.
- ② Place an insulating support (whose thickness is 10cm) onto the ground reference plane and put EUT on the support (so that the EUT can be isolated from the ground reference plane).
- ③ Connect LINE OUT on the front panel of the simulator to EUT with a cable (whose length is 50cm) and start operation of EUT.
- ④ Set the required test conditions (like the burst voltage, etc.) and start the test.

In case of table top EUT

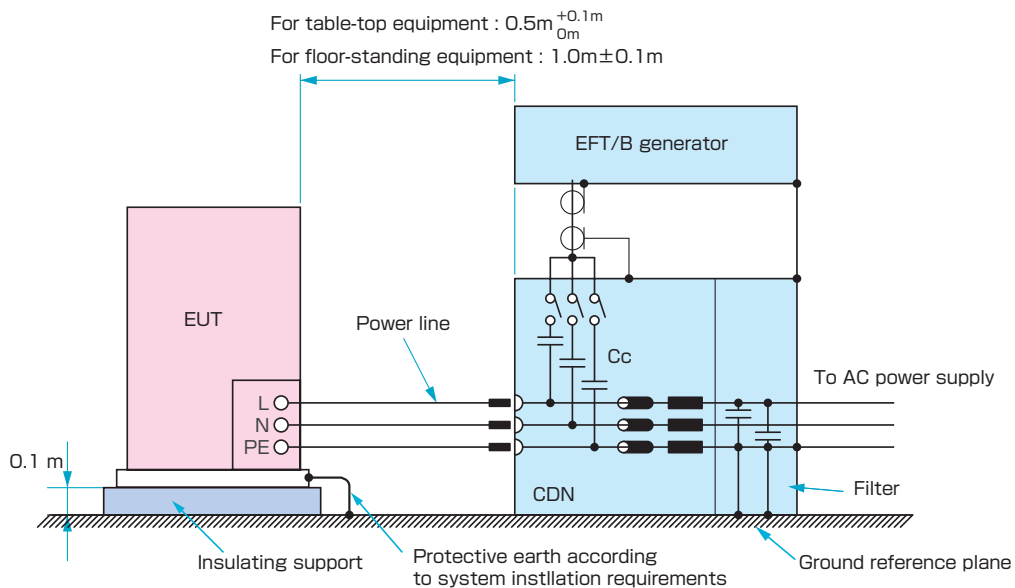
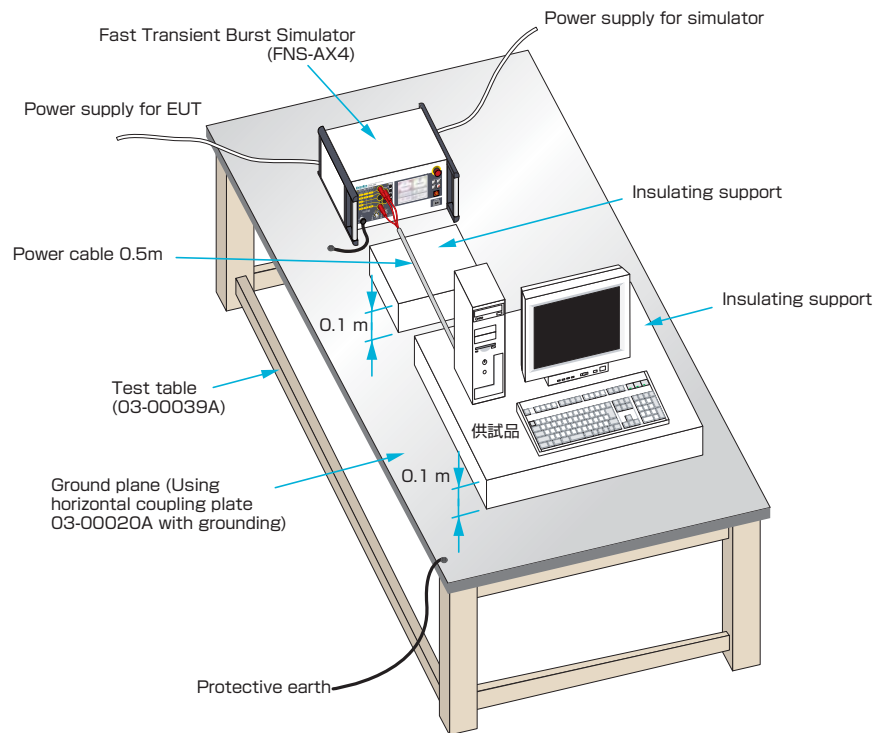

IEC61000-4-4 Ed.3 Test Standard

■ Test Method to Interconnection Lines

- ① Put the simulator onto ground reference plane which is connected to the protective ground and connect SG terminal on the front panel to the ground reference plane.
- ② Place the coupling clamp (Option) onto the ground reference plane.
- ③ Connect PULSE OUT port to connector of the coupling clamp.
- ④ Pass the line cable through the coupling clamp. Adjust the clamping part so that the coupling capacity can be largest (space between the cable and clamp can be minimum).
- ⑤ Cover the coupling clamp for preventing the electrical shock, Set the required test conditions (like the burst voltage, etc.)

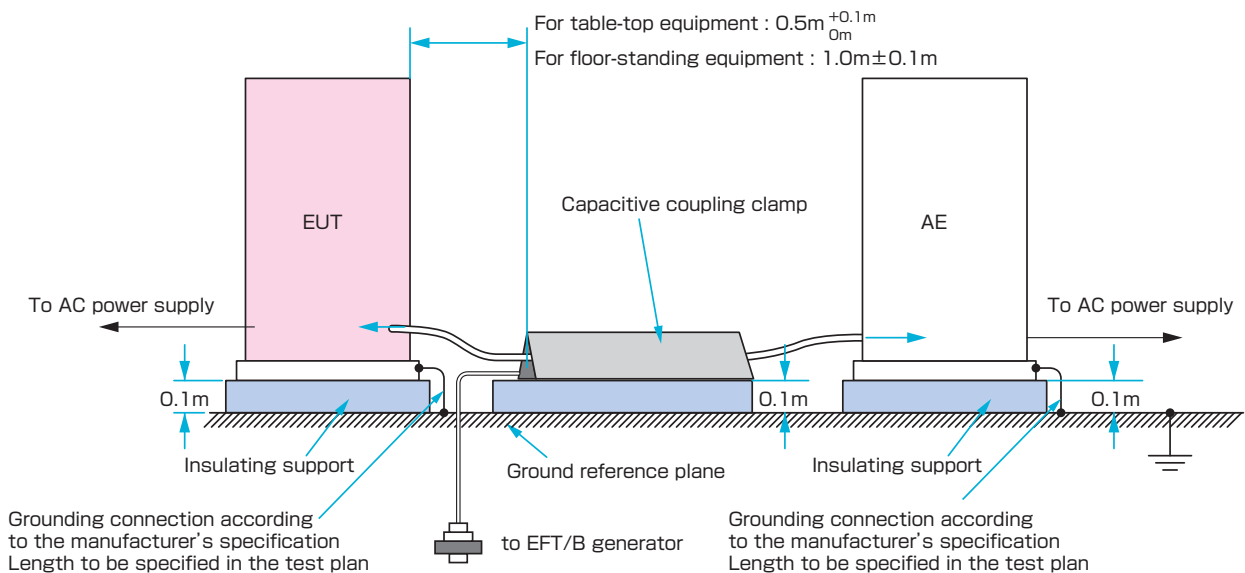
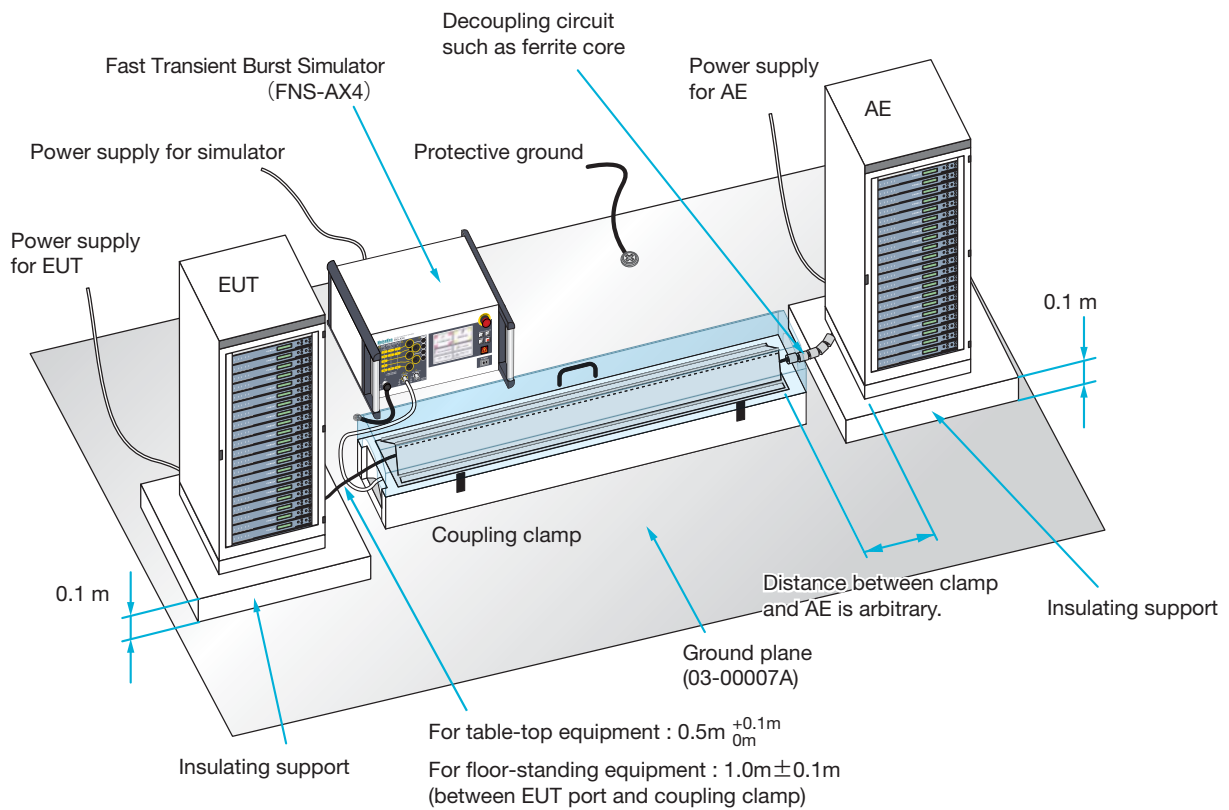

IEC61000-4-4 Ed.3 Test Standard

5. Test Procedure

The test shall be carried out on the basis of a test plan that shall include the verification of the performances of the EUT as defined in the technical specification.

- Type of test that will be carried out;
- Test level;
- Polarity of the test voltage (both polarities are mandatory);
- Internal or external generator;
- Duration of the test not less than 1 min
- Number of applications of the test voltage;
- EUT's ports to be tested;
- Representative operating conditions of the EUT;
- Sequence of application of the test voltage to the EUT's ports.
- Auxiliary equipment.

6. Evaluation of Test Results and Test Report

Classify tests results as below in terms of specifications and operating conditions of EUT.

- 1) Normal performance within limits specified by the manufacturer, requestor or purchaser;
- 2) Temporary loss of function or degradation of performance which ceases after the disturbance ceases, and from which the equipment under test recovers its normal performance, without operator intervention;
- 3) Temporary loss of function or degradation of performance, the correction of which requires operator intervention;
- 4) Loss of function or degradation of performance which is not recoverable, owing to damage to hardware or software, or loss of data.

Notes: This test procedure and test set-up are extracted from IEC61000-4-4 Ed.3 (2012) and JIS C 61000-4-4 standards for applying to our products. Please go through the Standards if the more details are required.

■ Test Method using various clamps (outside of IEC 61000-4-4 compliance testing)

Test Method using Fast Transient / Burst Simulator

- ① Place the simulator onto the ground plane which is connected to the protective earth and connect SG terminal on the front panel to the ground plane.
- ② Connect power cable (Standard accessory) to AC IN on the back of the simulator.
- ③ Place coupling adaptor CA-805B (Option) onto the ground plane and connect G terminal on side connector part of the clamp to the ground plane.
- ④ Connect PULSE OUT connector on the front of the simulator to connector of the adaptor.
(Fully pay attention to that any high voltage must not be put out during the connection)
- ⑤ Clamp the interconnection lines to be tested with the adaptor.
- ⑥ Set the test conditions like the coupling voltage, etc. , by the touch-panel on the simulator and start the test.

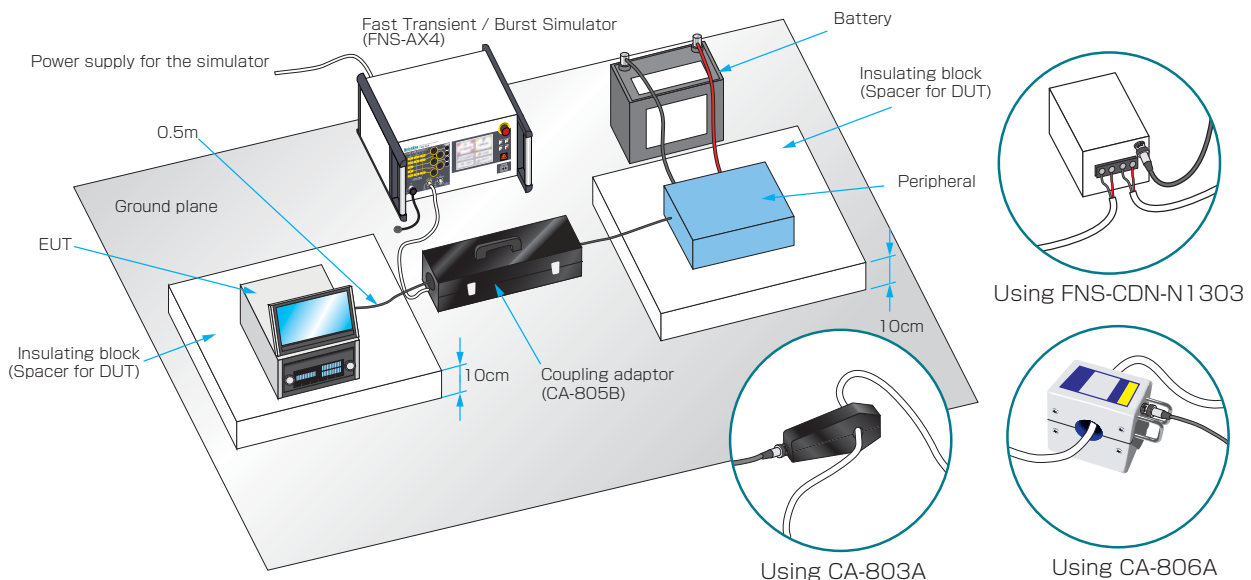

NoiseKen

NOISE LABORATORY

NOISE LABORATORY CO.,LTD

<http://www.noiseken.com>

International Sales & Marketing Section

1-4-4 Chiyoda, Chuo-ku, Sagamiara City, Kanagawa Pref. 252-0237 Japan

TEL: +81-(0)42-712-2051 FAX: +81-(0)42-712-2050

E-mail : sales@noiseken.com



Authorized representative