

MODEL 6310A SERIES

KEY FEATURES

- Max Power: 200W, 100W×2(Dual), 30W & 250W, 300W, 350W, 600W, 1200W
- Wide range 0~600V operating voltage
- Compatibility between 6310 and 6310A
- Up to eight channels in one mainframe, for testing multiple output SMPS
- Parallel load modules up to 1200W for high current and power applications
- Synchronization with multiple loads
- Flexible CC, CR, CP and CV operation modes
- Dynamic loading with speeds up to 20kHz
- Fast response of 0.32mA/μs ~ 10A/μs slew rate
- Minimum input resistance allows load to sink high current at low voltage (63123A : 0.6V@70A)
- Real time power supply load transient response simulation and output measurements
- User programmable 100 sequences. Front panel input status for user-friendly operation
- High/Low limits of testing parameters to test GO/NG
- Digital I/O control
- Over current protection (OCP) testing function
- 16-bit precision voltage and current measurement with dual-range
- Remote sensing capability
- Short circuit test
- Self-test at power-on
- Full Protection: OC, OP, OT protection and OV, reverse alarm
- USB, GPIB & RS-232C interfaces

PROGRAMMABLE DC ELECTRONIC LOAD MODEL 6310A SERIES

Chroma's Programmable DC Electronic Load 6310A series is ideal for the test and evaluation of multi-output AC/DC power supplies, DC/DC converters, chargers and power electronic components. It is designed for applications in research and development, production, and incoming inspection. The system is configured by plugging the user selectable load modules into the system mainframe. The user interfaces include an ergonomically designed user friendly keypad on the front panel and the following computer interfaces: RS-232C, USB or GPIB.

The 6310A series offers 12 different modules with power ratings from 20 watts to 1,200 watts, current ratings from 0.5mA to 240A, and voltage ratings from 0.5mV to 600V. The loads can be operated in constant current, constant voltage, constant power and constant resistance and may be placed in parallel for increased current and power.

The 6310A series can simulate a wide range of dynamic loading applications. The waveforms programmable parameters include: slew rate, load level, duration and conducting voltage. In addition, up to 100 sets of system operating status can be stored in EEPROM and recalled instantly for automated testing applications.

Real time measurement of voltage and current are integrated into each 6310A load module using a 16-bit precision measurement circuit. The user can perform on line voltage measurements and adjustments or simulate short circuit test using the user friendly keypad on the front panel. Additionally, the 6310A series offers an optional remote controller for automated production lines.

The 6310A series has a self-diagnosis routines to maintain instrument performance. It also provides OC, OP, OT protection, and alarm indicating OV, reverse polarity to guarantee quality and reliability for even in the most demanding engineering testing and ATE applications.



Chroma
Advancing Excellence

Versatile System Configuration

Chroma 6310A Programmable Electronic Load integrates microprocessor capabilities into each load module and mainframe to provide simple and accurate parallel operation to optimize the speed and control among multiple load modules. All load modules may be configured to work synchronously, thus simulating real life applications.

6310A System Block Diagram

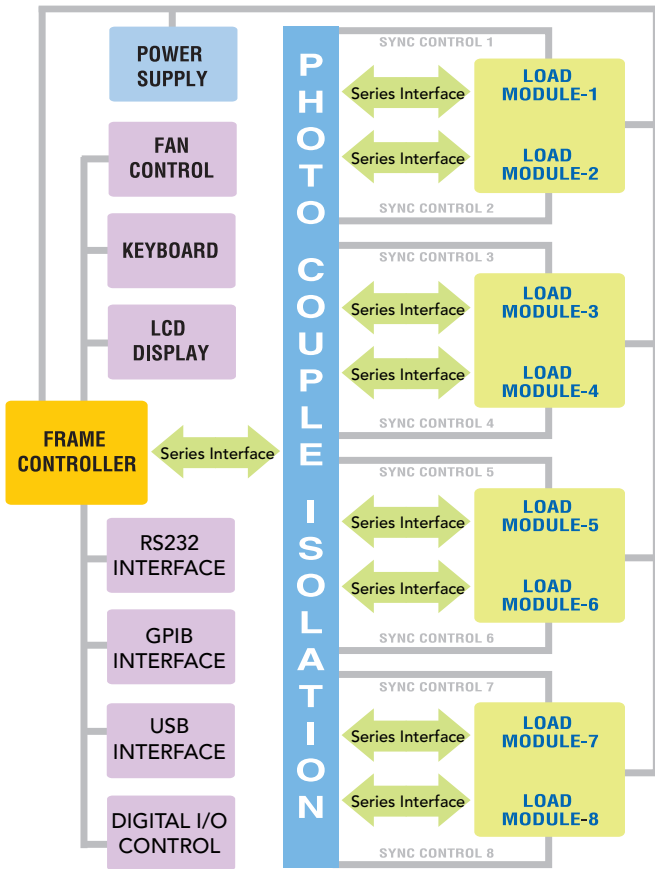

COMPATIBILITY WITH 6310 SERIES

The 6310A series load modules will be compatible with the 6310 series mainframes (6312/6314). In addition, the remote control commands will be compatible between the 6310 and the 6310A series without needing to re-writing any remote control programs.

MODULE LOAD DESIGN

The Chroma 6314A 1400W and 6312A 700W electronic load mainframes accept the user-installable 6310A series load modules for easy system configuration and will mount in a 19" instrument rack. The 6314A holds up to four 63102A load modules, which will result in an 8-channel 100W/channel load with standard

front-panel inputs. This makes it ideal for testing multiple output switching power supplies and multiple DC-DC converters. There are also higher wattage modules that may be mixed and matched for an even more versatile system. Additionally, the GO/NG output port is useful for UUT's pass/fail testing on an automated production line. All modules on the 6314A/6312A mainframe share a common GPIB address to synchronize and speed up the control of the load modules and the read-back of data.



APPLICATION OF SPECIFIC LOAD SIMULATION

The 6310A load modules operate in constant current, constant voltage, constant power or constant resistance to satisfy a wide range of test requirements. For example, the test of a battery charger can be simulated easily by setting the load to operate in constant voltage.

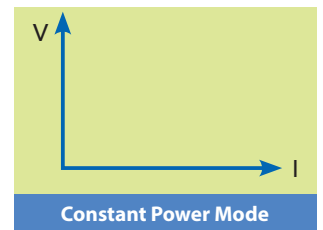
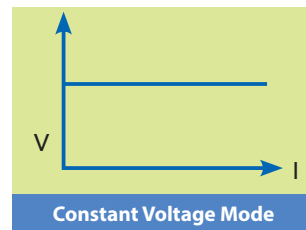
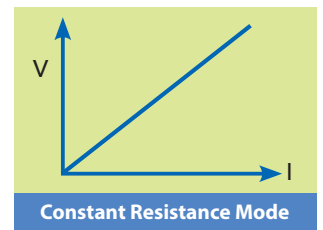
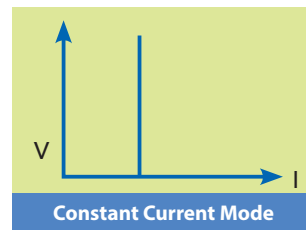

Each load module is designed with state-of-the-art technology and connects all the power MOSFET devices in parallel to insure high accuracy load control with a minimum drift of less than 0.1%+0.1%F.S. of the current setting. Chroma's use of FET technology provides minimum input resistance and enables the load to sink high current even at very low voltages. For example,

the model 63123A is capable of sinking 70A at 0.6V, and well-suited for testing the new 3.3V low voltage power supplies. Low voltage operation, down to zero volts, is possible at reduced current levels.

The 6310A load module uses a photo coupler for isolation between the output and control sections, thus each load is isolated and floating. The user can use multiple load modules independently to test multi-output power supplies, or parallel them for high power testing applications.

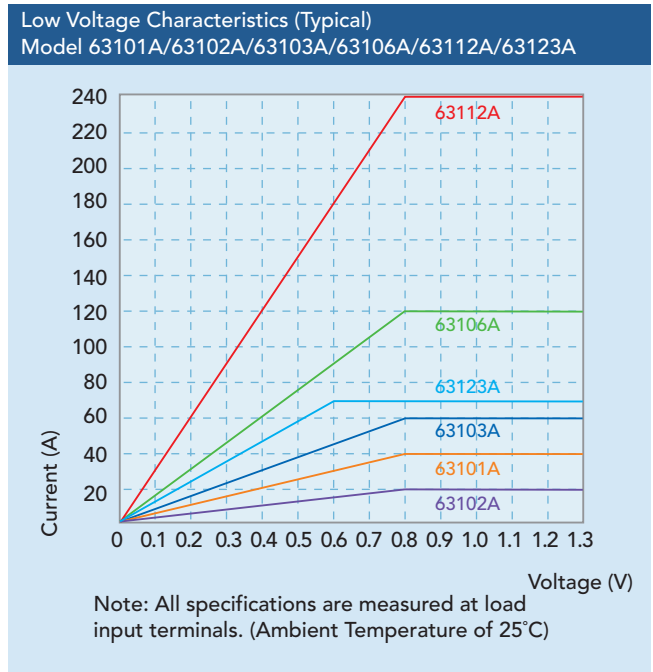
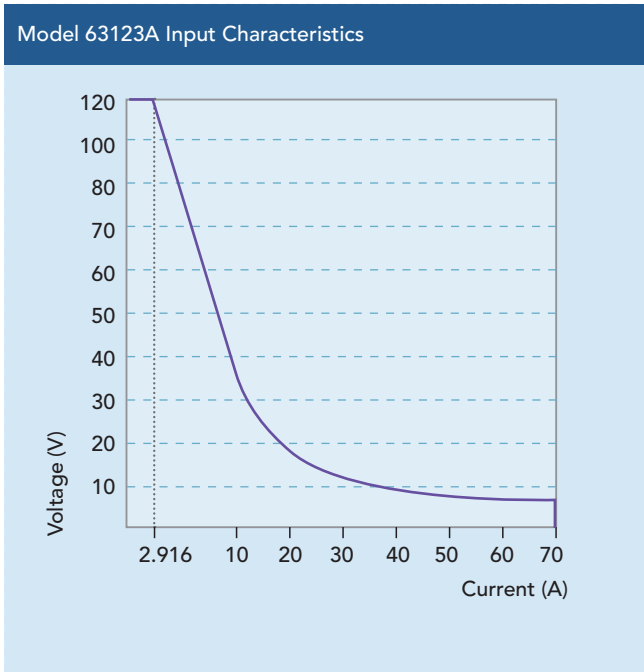

DYNAMIC LOADING AND CONTROL

Modern electronic devices operate at very high speeds and require fast dynamic operation of their power providing components. To satisfy these testing applications, the 6310A loads offer high speed, programmable dynamic load simulation and control capability. The figure aside shows the programmable parameters of the 6310A modules:

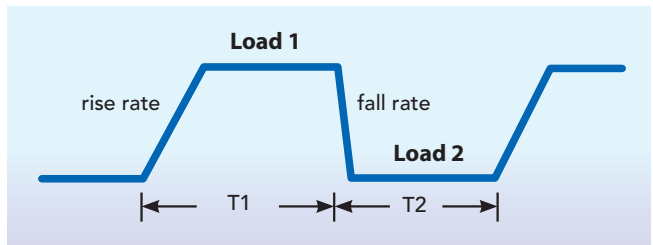

The programmable slew rate makes the simulation of transient load change demanded by real life applications possible. The 6310A internal waveform generator is capable of producing a maximum slew rate at 10A/μs, and dynamic cycling up to 20kHz. It's dedicated remote load sense and control circuit guarantee minimum waveform distortion during continuous load changes.

MULTI-CHANNEL CONTROL

The 6310A comes with RS-232C as standard for remote control and automated testing applications. The USB and GPIB interfaces are available as options. In addition, the 6310A provides an efficient solution for testing single output AC to DC or DC to DC converters by controlling multiple loads. The 6310A provides the capability to test up to 8 UUTs at a time.

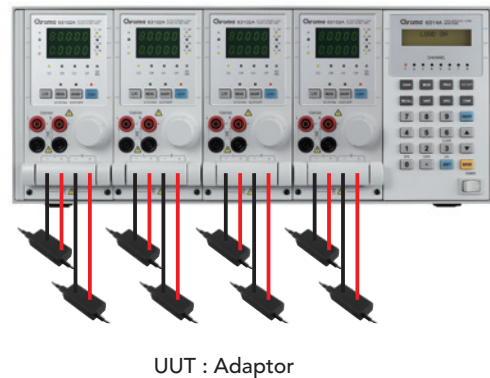

POWERFUL MEASUREMENTS

Each 6310A load module has an integrated 16-bit precision A/D converter for voltage measurement with an accuracy of 0.025%+0.015%* of full scale. The built-in resistive load current sensing circuit is capable of measuring current with an accuracy of 0.04%+0.04%* of full scale. Apart from voltage and current measurement, 6310A also provides power measurement function and there is no need for users to spend time for power calculation. Also, short circuit can be simulated. All measurements are done using remote sensing to eliminate any error due to voltage drops along the measurement path. The user can also select from a complete set of voltage and current measurements.

Note *: Only for Model 63123A

OCP TEST

Modern switching power supplies are designed with over current protection (OCP) circuitry; therefore, it is important to test the OCP circuitry to make sure it is functioning within its designed specifications. The 6310A series provides an easy and fast solution for this testing.

By simply choosing the channel and setting the OCP parameters (start current, end current, step current and dwell time) from the front panel, the 6310A series provides a fast and easy OCP testing solution. The 6310A series will automatically detect the OCP point, making it an ideal solution for design verification as well as production line testing.

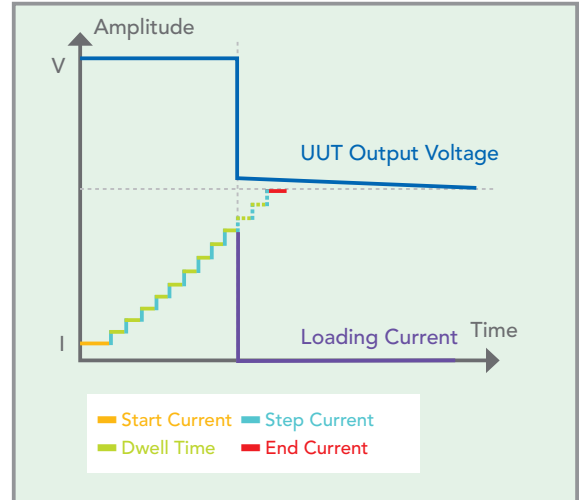

TIMING FUNCTION

The 6310A series of loads include a unique timing & measurement function, which allows precise time measurements in the range of 1ms to 86,400s. This feature allows the user to set the final voltage & timeout values for battery discharge testing, super capacitor discharge, and other similar applications.

For example, the figure on the right shows the 6310A internal timer starting at Load ON, and ending when the battery voltage reaches the final voltage.

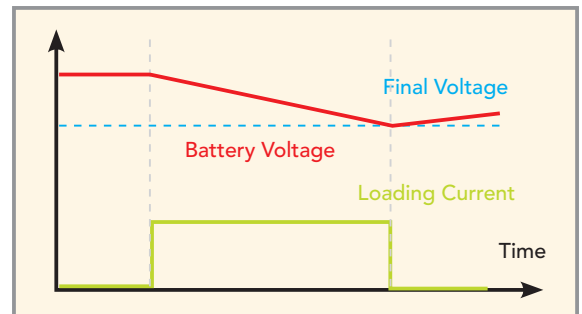

DIGITAL I/O

The digital I/O interface makes the 6310A DC Load the ideal choice for automated testing requirements. Through the digital I/O, the 6310A can accept digital signals to trigger its functions (Load On/Off, OCP test, etc.) as well as current output status signals.

Pin	Definition	Pin	Definition
Pin 1	Reserved	Pin 9	Short Signal (O/P)
Pin 2	DGND	Pin 10	Protection Signal (O/P)
Pin 3	DGND	Pin 11	External Load ON/OFF (I/P)
Pin 4	DGND	Pin 12	Reserved
Pin 5	DGND	Pin 13	Reserved
Pin 6	Load ON/OFF (O/P)	Pin 14	DGND
Pin 7	Total Pass (O/P)	Pin 15	External Trig. For Sequences Run (I/P)
Pin 8	Total Fail (O/P)		

6310A SERIES PROGRAMMABLE DC ELECTRONIC LOAD FAMILY



6314A : 4 in 1 Mainframe



6312A : 2 in 1 Mainframe



A631001:
Remote Controller

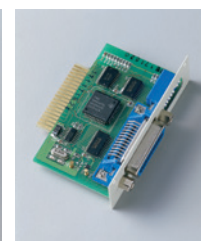

A631000 :
GPIB Interface



A631003 :
USB Interface

Mainframe Model	6312A	6314A
Number of slots	2	4
Operating Temperature	0~40°C	0~40°C
Input Rating	1Ø 100/200Vac ± 10% V _{LNr} , 47~63Hz ; 1Ø 115/230Vac ± 10% V _{LNr} , 47~63Hz	1Ø 100/200Vac ± 10% V _{LNr} , 47~63Hz ; 1Ø 115/230Vac ± 10% V _{LNr} , 47~63Hz
Dimensions (HxWxD)	194x275x550mm / 7.6x10.8x21.7inch	194x439x550mm / 7.6x17.3x21.7inch
Weight	15 kg / 33.1 lbs	21.5 kg / 47.4 lbs

LED LOAD SIMULATOR

As a constant current source, the LED power driver has an output voltage range with a constant output current. LED power drivers are usually tested in one of the following ways :

1. With LEDs
2. Using resistors for loading
3. Using Electronic Loads in Constant Resistance (CR) mode, or Constant Voltage (CV) mode

However, all these testing methods, each of them has their own disadvantages.



As shown on the V-I curve in Figure 1, the LED has a forward voltage V_F and a operating resistance (R_d). When using a resistor as loading, the V-I curve of the resistor is not able to simulate the V-I curve of the LED as shown in blue on Figure 1. This may cause the LED power driver to not start up due to the difference in V-I characteristic between the resistors and the LEDs. When using Electronic Loads, the CR and CV mode settings are set for when the LED is under stable operation and therefore, is unable to simulate turn on or PWM brightness control characteristics. This may cause the LED power driver to function improperly or trigger it's protection circuits. These testing requirements can be achieved when using a LEDs as a load; however, issues regarding the LED aging as well as different LED power drivers may require different types of LEDs or a number of LEDs. This makes it inconvenient for mass production testing.

Chroma has created the industries first LED Load Simulator for simulating LED loading with our 63110A load model from our 6310A series Electronic Loads. By setting the LED power driver's output voltage, and current, the Electronic Load can simulate the LED's loading characteristics. The LED's forward voltage and operating resistance can also be set to further adjust the loading current and ripple current to better simulate LED characteristics. The 63110A design also has increased bandwidth to allow for PWM dimming testing.

Figure 4 shows the dimming current waveform of the LED.

Figure 5 shows the dimming current waveform when using 63110A as a load.

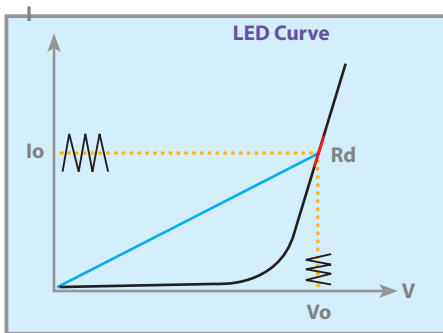

Figure 1 - LED V-I characteristics

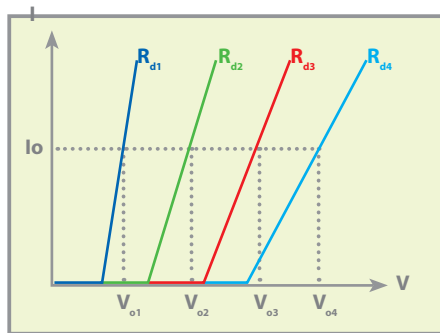

Figure 2 - Simulate different number of LEDs

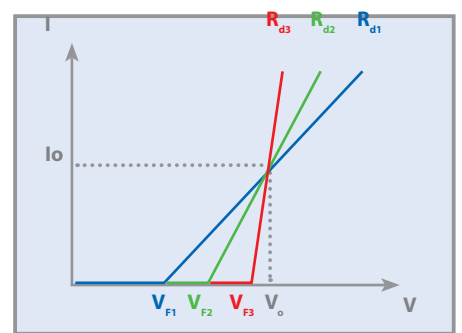

Figure 3 - Simulate different characteristic of LEDs

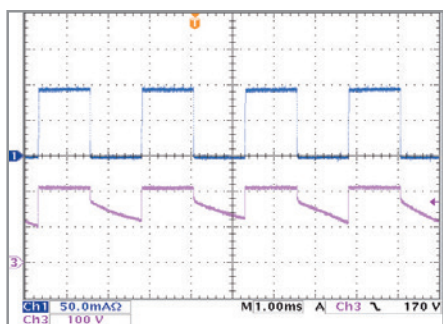

Figure 4 - LED dimming test

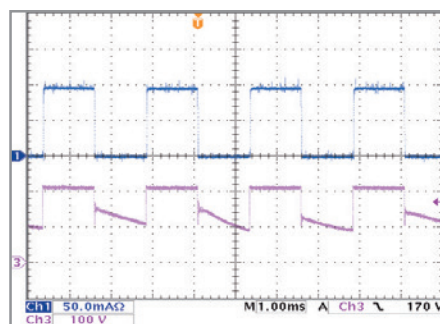

Figure 5 - 63110A dimming test

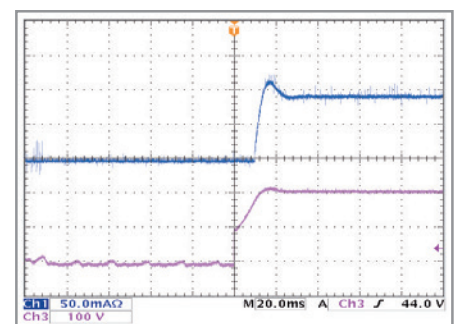
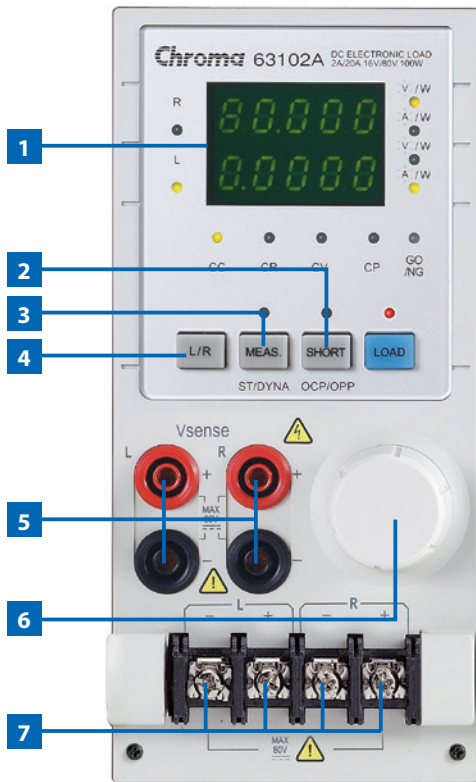
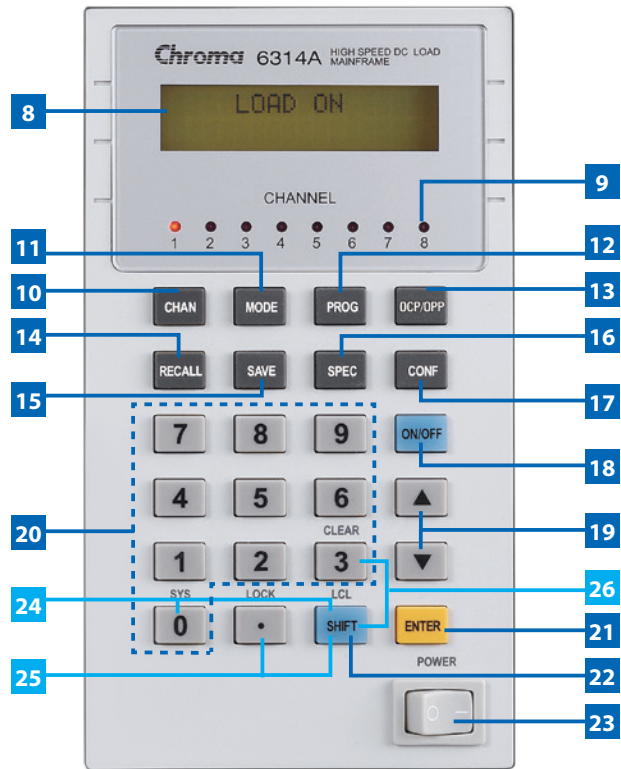

Figure 6 - LED driver turn-on waveform

Load Module



Mainframe Controller



Rear Panel



- | | |
|--|---|
| <ul style="list-style-type: none"> 1 LED indicator 2 SHORT key : To apply a short circuit across the input 3 STATIC/DYNA key : To select static or dynamic test mode 4 L/R key : To select left or right channel of input load (63102A, 63107A)
A/B key : To select static A or B load (other models) 5 V terminal : To measure the UUT's output voltage using remote sense 6 Rotary knob : To adjust load setting continuously 7 Load terminal 8 LCD display 9 LED indicator : To display the channel at which load is set 10 CHAN key : To select input load channel 11 MODE key : To select the operation mode of CC, CR, CV or CP 12 PROG key : For program data setting 13 OCP/OPP key : Over current protection/Over power protection testing 14 RECALL key : To recall the front panel input status from memory 15 SAVE key : To save the front panel input status into memory 16 SPEC key : To set up High/Low limits for GO/NG test 17 CONF key : To set the configuration | <ul style="list-style-type: none"> 18 ON/OFF key : To enable or disable the load input 19 Up/Down key : To select the next or previous display in edit mode 20 Numeric key : For data setting 21 ENTER key : To confirm editing data on the instrument 22 SHIFT key : As LOCAL key when in remote mode 23 Power switch 24 SHIFT + 0 key : System function 25 SHIFT + . key : Lock function 26 SHIFT + 3 key : Clear the currently edited data 27 Digital I/O : Used for system input/output control signals 28 RS-232C connector 29 GO/NG output port 30 GPIB or USB slot 31 AC input voltage switch 32 AC input fuse 33 AC input connector |
|--|---|

SPECIFICATIONS - LED LOAD SIMULATOR

Model	63110A (100Wx2)		63113A		63115A	
Power	100W		300W		300W	
Current	0~0.6A	0~2A	0~5A	0~20A	0~5A	0~20A
Voltage *1	0~500V		0~300V		0~600V	
Min. Operating Voltage (DC) Typical*1	0.9V@0.3A 1.8V@0.6A	3V@1A 6V@2A	0.5V@2.5A 1V@5A	2V@10A 4V@20A	0.5V@2.5A 1V@5A	2V@10A 4V@20A
Constant Current Mode						
Range	0~0.6A	0~2A	0~5A	0~20A	0~5A	0~20A
Resolution	12μA	40μA	100μA	400μA	100μA	400μA
Accuracy	0.1%+0.1% F.S.		0.1%+0.1% F.S.	0.1%+0.2% F.S.	0.1%+0.1% F.S.	0.1%+0.2% F.S.
Constant Resistance Mode						
Range	CRL : 3Ω~1kΩ (100W/100V) CRH : 10Ω~10kΩ (100W/500V)		CRL @ CH : 0.2Ω~200Ω (300W/60V) CRL @ CL : 0.8Ω~800Ω (300W/60V) CRH @ CL : 4Ω~4kΩ (300W/300V)		CRL @ CH : 0.2Ω~200Ω (300W/60V) CRL @ CL : 0.8Ω~800Ω (300W/60V) CRH @ CL : 8Ω~8kΩ (300W/600V)	
Resolution*2	CRL : 62.5μS CRH : 6.25μS		CRL @ CH : 100μS CRL @ CL : 25μS CRH @ CL : 5μS		CRL @ CH : 100μS CRL @ CL : 25μS CRH @ CL : 2.5μS	
Accuracy	CRL : 4mS+0.2% CRH : 1mS+0.1%		CRL @ CH : 10mS+0.2% CRL @ CL : 2.5mS+0.2% CRH @ CL : 0.5mS+0.2%		CRL @ CH : 10mS+0.2% CRL @ CL : 2.5mS+0.2% CRH @ CL : 0.25mS+0.2%	
Constant Voltage Mode						
Range	0~500V		0~300V		0~600V	
Resolution	20mV		6mV		12mV	
Accuracy	0.05% + 0.1%F.S.		0.05% + 0.1%F.S.		0.05% + 0.1%F.S.	
LED Mode						
Range	Operating Voltage: 0~100V/0~500V R _d Coefficient : 0.001~1 V _F : 0~100V/0~500V Current : 0~2A R _d : 1Ω~1kΩ/10Ω~10kΩ		Operating Voltage : 0~60V / 0~300V R _d Coefficient : 0.001~1 V _F : 0~60V/0~300V LEDL @ CH : 0~60V / 0~20A (R _d : 0.05Ω~50Ω) LEDL @ CL : 0~60V / 0~5A (R _d : 0.8Ω~800Ω) LEDH @ CL : 0~300V / 0~5A (R _d : 4Ω~4kΩ)		Operating Voltage : 0~60V / 0~600V R _d Coefficient : 0.001~1 V _F : 0~60V / 0~600V LEDL @ CH : 0~60V / 0~20A (R _d : 0.05Ω~50Ω) LEDL @ CL : 0~60V / 0~5A (R _d : 0.8Ω~800Ω) LEDH @ CL : 0~600V / 0~5A (R _d : 8Ω~8kΩ)	
Resolution *2	V _o : 4mV/20mV I _o : 0.04mA R _d Coefficient : 0.001 R _d : 62.5μS/6.25μS V _F : 4mV/20mV		V _o : 1.2mV/6mV I _o : 100μA/400μA R _d Coefficient : 0.001 R _d : 400μS / 25μS / 5μS 6mV/30mV		V _o : 1.2mV/12mV I _o : 100μA/400μA R _d Coefficient : 0.001 R _d : 400μS/25μS/2.5μS V _F : 6mV/ 60mV	
Dynamic Mode						
Dynamic Mode	--		C.C. Mode		C.C. Mode	
T1 & T2	--		0.025ms ~ 50ms / Res: 5μs 0.1ms ~ 500ms / Res: 25μs 10ms ~ 50s / Res: 2.5ms		0.025ms ~ 50ms / Res: 5μs 0.1ms ~ 500ms / Res: 25μs 10ms ~ 50s / Res: 2.5ms	
Accuracy	--		1μs/1ms+100ppm		1μs/1ms+100ppm	
Slew Rate	--		0.8~200mA/μs 3.2~800mA/μs		0.8~200mA/μs 3.2~800mA/μs	
Resolution	--		0.8mA/μs 3.2mA/μs		0.8mA/μs 3.2mA/μs	
Accuracy	--		10% ±20μs		10% ±20μs	
Min. Rise Time	--		25μs (Typical)		25μs (Typical)	
Current	--		0~5A 0~20A		0~5A 0~20A	
Resolution	--		100μA 400μA		100μA 400μA	
Accuracy	--		0.4%F.S.		0.4%F.S.	
Measurement Section						
Voltage Read Back						
Range	0~100V	0~500V	0~60V	0~300V	0~60V	0~600V
Resolution	2mV	10mV	1.2mV	6mV	1.2mV	12mV
Accuracy	0.025%+0.025% F.S.		0.025%+0.025% F.S.		0.025%+0.025% F.S.	
Current Read Back						
Range	0~0.6A	0~2A	0~5A	0~20A	0~5A	0~20A
Resolution	12μA	40μA	100μA	400μA	100μA	400μA
Accuracy	0.05%+0.05% F.S.		0.05%+0.05% F.S.		0.05%+0.05% F.S.	

NOTE*1 : If the operating voltage exceeds 1.1 times of the rated voltage, it would cause permanent damage to the device.

NOTE*2 : S (siemens) is the SI unit of conductance, equal to one reciprocal ohm.

SPECIFICATIONS-1

Model	63101A		63102A (100Wx2)		63103A	
Power	20W	200W	20W	100W	30W	300W
Current	0~4A	0~40A	0~2A	0~20A	0~6A	0~60A
Voltage *3	0~80V		0~80V		0~80V	
Typical Min. Operation Voltage (DC)*1	0.4V@2A 0.8V@4A	0.4V@20A 0.8V@40A	0.4V@1A 0.8V@2A	0.4V@10A 0.8V@20A	0.4V@3A 0.8V@6A	0.4V@30A 0.8V@60A
Constant Current Mode						
Range	0~4A	0~40A	0~2A	0~20A	0~6A	0~60A
Resolution	1mA	10mA	0.5mA	5mA	1.5mA	15mA
Accuracy	0.1%+0.1%F.S.	0.1%+0.2%F.S.	0.1%+0.1%F.S.	0.1%+0.2%F.S.	0.1%+0.1%F.S.	0.1%+0.2%F.S.
Constant Resistance Mode						
Range	0.0375Ω~150Ω (200W/16V) 1.875Ω~7.5kΩ (200W/80V)		0.075Ω~300Ω (100W/16V) 3.75Ω~15kΩ (100W/80V)		0.025Ω~100Ω (300W/16V) 1.25Ω~5kΩ (300W/80V)	
Resolution*5	6.667mS (200W/16V) 133μS (200W/80V)		3.333mS (100W/16V) 66.667μS (100W/80V)		10mS (300W/16V) 200μS (300W/80V)	
Accuracy	150Ω: 0.1S+ 0.2% 7.5kΩ: 0.01S+ 0.1%		300Ω: 0.1S+ 0.2% 15kΩ: 0.01S+ 0.1%		100Ω: 0.1S+ 0.2% 5kΩ: 0.01S+ 0.1%	
Constant Voltage Mode						
Range	0~80V		0~80V		0~80V	
Resolution	20mV		20mV		20mV	
Accuracy	0.05% + 0.1%F.S.		0.05% + 0.1%F.S.		0.05% + 0.1%F.S.	
Constant Power Mode						
Range	0~20W	0~200W	0~20W	0~100W	0~30W	0~300W
Resolution	5mW	50mW	5mW	25mW	7.5mW	75mW
Accuracy*2	0.5% + 0.5%F.S.		0.5% + 0.5%F.S.		0.5% + 0.5%F.S.	
Dynamic Mode						
Dynamic Mode	C.C. Mode		C.C. Mode		C.C. Mode	
T1 & T2	0.025ms ~ 50ms / Res: 5μs 0.1ms ~ 500ms / Res: 25μs 10ms ~ 50s / Res: 2.5ms		0.025ms ~ 50ms / Res: 5μs 0.1ms ~ 500ms / Res: 25μs 10ms ~ 50s / Res: 2.5ms		0.025ms ~ 50ms / Res: 5μs 0.1ms ~ 500ms / Res: 25μs 10ms ~ 50s / Res: 2.5ms	
Accuracy	1μs/1ms+100ppm		1μs/1ms+100ppm		1μs/1ms+100ppm	
Slew Rate	0.64~160mA/μs	6.4~1600mA/μs	0.32~80mA/μs	3.2~800mA/μs	0.001~0.25A/μs	0.01~2.5A/μs
Resolution	0.64mA/μs	6.4mA/μs	0.32mA/μs	3.2mA/μs	0.001A/μs	0.01A/μs
Accuracy	10% ±20μs		10% ±20μs		10% ±20μs	
Min. Rise Time	10μs (Typical)		10μs (Typical)		10μs (Typical)	
Current	0~4A	0~40A	0~2A	0~20A	0~6A	0~60A
Resolution	1mA	10mA	0.5mA	5mA	1.5mA	15mA
Accuracy	0.4%F.S.		0.4%F.S.		0.4%F.S.	
Measurement Section						
Voltage Read Back						
Range	0~16V	0~80V	0~16V	0~80V	0~16V	0~80V
Resolution	0.25mV	1.25mV	0.25mV	1.25mV	0.25mV	1.25mV
Accuracy	0.025% + 0.025%F.S.		0.025% + 0.025%F.S.		0.025% + 0.025%F.S.	
Current Read Back						
Range	0~4A	0~40A	0~2A	0~20A	0~6A	0~60A
Resolution	0.0625mA	0.625mA	0.03125mA	0.3125mA	0.09375mA	0.9375mA
Accuracy	0.05% + 0.05%F.S.		0.05% + 0.05%F.S.		0.05% + 0.05%F.S.	
Power Read Back						
Range	0~20W	0~200W	0~20W	0~100W	0~30W	0~300W
Accuracy*2	0.1% + 0.1%F.S.		0.1% + 0.1%F.S.		0.1% + 0.1%F.S.	
Protective Section						
Over Power Protection	Yes		Yes		Yes	
Over Current Protection	Yes		Yes		Yes	
Over Temperature Protection	Yes		Yes		Yes	
Over Voltage Alarm*3	Yes		Yes		Yes	
General						
Short Circuit						
Current (CC)	-	Yes	-	Yes	-	Yes
Voltage (CV)	-	Yes	-	Yes	-	Yes
Resistance (CR)	-	Yes	-	Yes	-	Yes
Power (CP)	-	Yes	-	Yes	-	Yes
Input Resistance (Load Off)	R≥100kΩ (Typical)		R≥100kΩ (Typical)		R≥100kΩ (Typical)	
Temperature Coefficient	100PPM/°C (Typical)		100PPM/°C (Typical)		100PPM/°C (Typical)	
Power	Supply from 6314A Mainframe		Supply from 6314A Mainframe		Supply from 6314A Mainframe	
Dimensions (HxWxD)	172x82x489.5mm / 6.8x3.2x19.3inch		172x82x489.5mm / 6.8x3.2x19.3inch		172x82x489.5mm / 6.8x3.2x19.3inch	
Weight	4.2 kg / 9.3 lbs		4.2 kg / 9.3 lbs		4.2 kg / 9.3 lbs	
Operating Range	0~40°C		0~40°C		0~40°C	
EMC & Safety	CE		CE		CE	

SPECIFICATIONS-2

Model	63105A		63106A		63107A (30W & 250W)		
Power	30W	300W	60W	600W	30W	30W	250W
Current	0~1A	0~10A	0~12A	0~120A	0~5A	0~4A	0~40A
Voltage*3	0~500V		0~80V		0~80V		
Typical Min. Operation Voltage (DC)*1	1.0V@0.5A	1.0V@5A	0.4V@6A	0.4V@60A	0.4V@2.5A	0.4V@2A	0.4V@20A
	2.0V@1A	2.0V@10A	0.8V@12A	0.8V@120A	0.8V@5A	0.8V@4A	0.8V@40A
Constant Current Mode							
Range	0~1A	0~10A	0~12A	0~120A	0~5A	0~4A	0~40A
Resolution	0.25mA	2.5mA	3mA	30mA	1.25mA	1mA	10mA
Accuracy	0.1%+0.1%F.S.	0.1%+0.2%F.S.	0.1%+0.1%F.S.	0.1%+0.2%F.S.	0.1%+0.1%F.S.	0.1%+0.1%F.S.	0.1%+0.2%F.S.
Constant Resistance Mode							
Range	1.25Ω~5kΩ (300W/125V) 50Ω~200kΩ (300W/500V)		12.5mΩ~50Ω (600W/16V) 0.625Ω~2.5kΩ (600W/80V)		0.3Ω~1.2kΩ (30W/16V) 15Ω~60kΩ (30W/80V)		0.0375Ω~150Ω (250W/16V) 1.875Ω~7.5kΩ (250W/80V)
Resolution*5	200μS (300W/125V) 5μS (300W/500V)		20mS (600W/16V) 400μS (600W/80V)		833μS (30W/16V) 16.67μS (30W/80V)		6.667μS (250W/16V) 133μS (250W/80V)
Accuracy	5kΩ: 20mS+ 0.2% 200kΩ:5mS+ 0.1%		50Ω: 0.4S + 0.5% 2.5kΩ: 0.04S + 0.2%		1.2kΩ: 0.1S + 0.2% 60kΩ: 0.01S + 0.1%		150Ω: 0.1S + 0.2% 7.5kΩ: 0.01S + 0.1%
Constant Voltage Mode							
Range	0~500V		0~80V		0~80V		
Resolution	125mV		20mV		20mV		
Accuracy	0.05% + 0.1%F.S.		0.05% + 0.1%F.S.		0.05% + 0.1%F.S.		
Constant Power Mode							
Range	0~30W	0~300W	0~60W	0~600W	0~30W	0~30W	0~250W
Resolution	7.5mW	75mW	15mW	150mW	7.5mW	7.5mW	62.5mW
Accuracy*2	0.5% + 0.5%F.S.		0.5% + 0.5%F.S.		0.5% + 0.5%F.S.		
Dynamic Mode							
Dynamic Mode	C.C. Mode		C.C. Mode		C.C. Mode		
T1 & T2	0.025ms ~ 50ms / Res: 5μs 0.1ms ~ 500ms / Res: 25μs 10ms ~ 50s / Res: 2.5ms		0.025ms ~ 50ms / Res: 5μs 0.1ms ~ 500ms / Res: 25μs 10ms ~ 50s / Res: 2.5ms		0.025ms ~ 50ms / Res: 5μs 0.1ms ~ 500ms / Res: 25μs 10ms ~ 50s / Res: 2.5ms		
Accuracy	1μs/1ms+100ppm		1μs/1ms+100ppm		1μs/1ms+100ppm		
Slew Rate	0.16~40mA/μs	1.6~400mA/μs	0.002~0.5A/μs	0.02~5A/μs	0.8~200mA/μs	0.64~160mA/μs	6.4~1600mA/μs
Resolution	0.16mA/μs	1.6mA/μs	0.002A/μs	0.02A/μs	0.8mA/μs	0.64mA/μs	6.4mA/μs
Accuracy	10% ±20μs		10% ±20μs		10% ±20μs		
Min. Rise Time	24μs (Typical)		10μs (Typical)		10μs (Typical)		
Current	0~1A	0~10A	0~12A	0~120A	0~5A	0~4A	0~40A
Resolution	0.25mA	2.5mA	3mA	30mA	1.25mA	1mA	10mA
Accuracy	0.4%F.S.		0.4%F.S.		0.4%F.S.		
Measurement Section							
Voltage Read Back							
Range	0~125V	0~500V	0~16V	0~80V	0~16V	0~80V	0~16V 0~80V
Resolution	2mV	8mV	0.25mV	1.25mV	0.25mV	1.25mV	0.25mV 1.25mV
Accuracy	0.025% + 0.025%F.S.		0.025% + 0.025%F.S.		0.025% + 0.025%F.S.		
Current Read Back							
Range	0~1A	0~10A	0~12A	0~120A	0~5A	0~4A	0~40A
Resolution	0.016mA	0.16mA	0.1875mA	1.875mA	0.078125mA	0.0625mA	0.625mA
Accuracy	0.05% + 0.05%F.S.		0.05% + 0.05%F.S.		0.05% + 0.05%F.S.		
Power Read Back							
Range	0~30W	0~300W	0~60W	0~600W	0~30W	0~30W	0~250W
Accuracy*2	0.1% + 0.1%F.S.		0.1% + 0.1%F.S.		0.1% + 0.1%F.S.		
Protective Section							
Over Power Protection	Yes		Yes		Yes		
Over Current Protection	Yes		Yes		Yes		
Over Temperature Protection	Yes		Yes		Yes		
Over Voltage Alarm*3	Yes		Yes		Yes		
General							
Short Circuit							
Current (CC)	-	Yes	-	Yes	-	-	Yes
Voltage (CV)	-	Yes	-	Yes	-	-	Yes
Resistance (CR)	-	Yes	-	Yes	-	-	Yes
Power (CP)	-	Yes	-	Yes	-	-	Yes
Input Resistance (Load Off)	R≥100kΩ (Typical)		R≥100kΩ (Typical)		R≥100kΩ (Typical)		
Temperature Coefficient	100PPM/°C (Typical)		100PPM/°C (Typical)		100PPM/°C (Typical)		
Power	Supply from 6314A Mainframe		Supply from 6314A Mainframe		Supply from 6314A Mainframe		
Dimensions (HxWxD)	172x82x489.5mm / 6.8x3.2x19.3inch		172x164x489.5mm / 6.8x6.5x19.3inch		172x82x489.5mm / 6.8x3.2x19.3inch		
Weight	4.2 kg / 9.3 lbs		7.3 kg / 16.1 lbs		4.5 kg / 9.9 lbs		
Operating Range	0~40°C		0~40°C		0~40°C		
EMC & Safety	CE		CE		CE		

NOTE*1 : Low voltage operation, under 0.8 volt, is possible at correspondingly reduced current level. Operating temperature range is 0°C to 40°C. All specifications apply for 25°C ±5°C, except as noted.

NOTE*2 : Power F.S. = Vrange F.S. x Irange F.S.

SPECIFICATIONS-3

Model	63108A		63112A		63123A	
Power	60W	600W	120W	1200W	350W	
Current	0~2A	0~20A	0~24A	0~240A	0~7A	0~70A
Voltage*3	0~500V		0~80V		0~120V	
Typical Min. Operation Voltage (DC)*1	1.0V@1A	1.0V@10A	0.4V@12A	0.4V@120A	0.05V@3.5A	0.3V@35A
	2.0V@2A	2.0V@20A	0.8V@24A	0.8V@240A	0.1V@7A	0.6V@70A
Constant Current Mode						
Range	0~2A	0~20A	0~24A	0~240A	0~7A	0~70A
Resolution	0.5mA	5mA	6mA	60mA	0.125mA	1.25mA
Accuracy	0.1%+0.1%F.S.	0.1%+0.2%F.S.	0.1%+0.1%F.S.	0.1%+0.2%F.S.	0.04%+0.04%F.S.	0.04%+0.04%F.S.
Constant Resistance Mode						
Range	0.625Ω~2.5kΩ (600W/125V) 25Ω~100kΩ (600W/500V)		6.25mΩ~25Ω (1200W/16V) 0.3125Ω~1.25kΩ (1200W/80V)		0.015Ω~150Ω (350W/24V)*4 2Ω~2kΩ (350W/120V)	
Resolution*5	400μS (600W/125V) 10μS (600W/500V)		40mS (1200W/16V) 800μS (1200W/80V)		1.33mS (350W/24V)*4 10μS (350W/120V)	
Accuracy	2.5kΩ: 50mS + 0.2% 100kΩ: 5mS + 0.1%		25Ω: 0.8S + 0.8% 1.25kΩ: 0.08S + 0.2%		150Ω: 67mS + 0.1% *4 2kΩ: 5mS + 0.2%	
Constant Voltage Mode						
Range	0~500V		0~80V		0~120V	
Resolution	125mV		20mV		2mV	
Accuracy	0.05% + 0.1%F.S.		0.05% + 0.1%F.S.		0.05% + 0.1%F.S.	
Constant Power Mode						
Range	0~60W	0~600W	0~120W	0~1200W	0~35W	0~350W
Resolution	15mW	150mW	30mW	300mW	2.5mW	25mW
Accuracy*2	0.5% + 0.5%F.S.		0.5% + 0.5%F.S.		0.5% + 0.5%F.S.	
Dynamic Mode						
Dynamic Mode	C.C. Mode		C.C. Mode		C.C. MODE	
T1 & T2	0.025ms ~ 50ms / Res: 5μs 0.1ms ~ 500ms / Res: 25μs 10ms ~ 50s / Res: 2.5ms		0.025ms ~ 50ms / Res: 5μs 0.1ms ~ 500ms / Res: 25μs 10ms ~ 50s / Res: 2.5ms		0.025ms~50ms/Res: 5μs 0.1ms~500ms / Res: 25μs 10ms~50s / Res: 2.5ms	
Accuracy	1μs/1ms+100ppm		1μs/1ms+100ppm		1μs /1ms+100ppm	
Slew Rate	0.32~80mA/μs	3.2~800mA/μs	0.004~1A/μs	0.04~10A/μs	0.001~0.25A/μs	0.01~2.5A/μs*4
Resolution	0.32mA/μs	3.2mA/μs	0.004A/μs	0.04A/μs	0.001A/μs	0.01A/μs*4
Accuracy	10% ± 20μs		10% ± 20μs		10% ± 20μs	
Min. Rise Time	24μs (Typical)		10μs (Typical)		25μs (Typical) *6	
Current	0~2A	0~20A	0~24A	0~240A	0~7A	0~70A
Resolution	0.5mA	5mA	6mA	60mA	0.125mA	1.25mA
Accuracy	0.4%F.S.		0.4%F.S.		0.1% F.S.	
Measurement Section						
Voltage Read Back						
Range	0~125V	0~500V	0~16V	0~80V	0~24V	0~120V
Resolution	2mV	8mV	0.25mV	1.25mV	0.4mV	2mV
Accuracy	0.025% + 0.025%F.S.		0.025% + 0.025%F.S.		0.025%+0.015% F.S.	
Current Read Back						
Range	0~2A	0~20A	0~24A	0~240A	0~7A	0~70A
Resolution	0.03125mA	0.3125mA	0.375mA	3.75mA	0.125mA	1.25mA
Accuracy	0.05% + 0.05%F.S.		0.075% + 0.075%F.S.		0.04%+0.04% F.S.	
Power Read Back						
Range	0~60W	0~600W	0~120W	0~1200W	0~35W	0~350W
Accuracy*2	0.1% + 0.1%F.S.		0.1% + 0.1%F.S.		0.1%+0.1% F.S.	
Protective Section						
Over Power Protection	Yes		Yes		Yes	
Over Current Protection	Yes		Yes		Yes	
Over Temperature Protection	Yes		Yes		Yes	
Over Voltage Alarm*3	Yes		Yes		Yes	
General						
Short Circuit						
Current (CC)	-	Yes	-	Yes	-	Yes
Voltage (CV)	-	Yes	-	Yes	-	Yes
Resistance (CR)	-	Yes	-	Yes	-	Yes
Power (CP)	-	Yes	-	Yes	-	Yes
Input Resistance (Load Off)	R≥100kΩ (Typical)		R≥100kΩ (Typical)		R≥800kΩ (Typical)	
Temperature Coefficient	100PPM/°C (Typical)		100PPM/°C (Typical)		100PPM/°C (Typical)	
Power	Supply from 6314A Mainframe		Supply from 6314A Mainframe		Supply from 6314A Mainframe	
Dimensions (HxWxD)	172x164x489.5mm / 6.8x6.5x19.3inch		172x329x495mm / 6.8x12.9x19.5inch		172x82x489.5mm / 6.8x3.2x19.3inch	
Weight	7.3 kg / 16.1 lbs		14 kg / 30.8 lbs		4.2kg / 9.3 lbs	
Operating Range	0~40°C		0~40°C		0~40°C	
EMC & Safety	CE		CE		CE	

NOTE*3 : When the operating voltage exceeds the rated voltage for 1.02 times, a warning will occur and if it exceeds 1.1 times of the rated voltage, it would cause permanent damage to the device.

NOTE*4 : Please refer to user's manual for detail specifications.

NOTE*5 : S (siemens) is the SI unit of conductance, equal to one reciprocal ohm.

NOTE*6 : The loading current should be 0.35A at least.

SOFTPANEL

The 6310A loads can be operated from the front panel controls of mainframe or from available softpanels. This user friendly software includes all functions of 6310A and is easy to understand and operate. The 6310A can be controlled via GPIB and USB interfaces for remote control and automated testing applications.

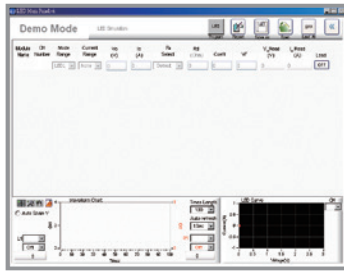

LED Mode

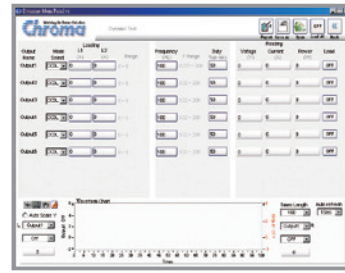

Dynamic Test



Battery Test

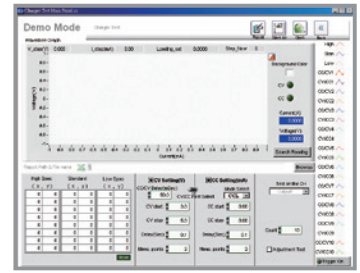

Charger Test

ORDERING INFORMATION

6312A : Mainframe for 2 Load Modules

6314A : Mainframe for 4 Load Modules

63101A : Load Module 80V/40A/200W

63102A : Load Module 80V/20A/100W x 2

63103A : Load Module 80V/60A/300W

63105A : Load Module 500V/10A/300W

63106A : Load Module 80V/120A/600W

63107A : Load Module 80V/5A & 40A/30W & 250W

63108A : Load Module 500V/20A/600W

63112A : Load Module 80V/240A/1200W

63123A : Load Module 120V/70A/350W

A631000 : GPIB Interface for Model 6314A/6312A Mainframe

A631001 : Remote Controller

A631003 : USB Interface for Model 6314A/6312A Mainframe

A631005 : Softpanel for 6310A/6330A series

A631006 : Rack Mounting Kit for Model 6312A Mainframe

A631007 : Rack Mounting Kit for Model 6314A Mainframe

A800042 : Test Fixture

LED Load Simulator for LED Driver Test

63110A : Load Module 500V/2A/100W x 2

63113A : Load Module 300V/20A/300W

63115A : Load Module 600V/20A/300W

Get more product & global distributor information in Chroma ATE APP



iOS



Android

Search Keyword

6310A

HEADQUARTERS
CHROMA ATE INC.
88 Wenmao Rd.,
Guishan Dist.,
Taoyuan City
333001, Taiwan
T +886-3-327-9999
F +886-3-327-8898
www.chromaate.com
info@chromaate.com

U.S.A.
CHROMA SYSTEMS
SOLUTIONS, INC.
19772 Pauling,
Foothill Ranch,
CA 92610
T +1-949-600-6400
F +1-949-600-6401
www.chromausa.com
sales@chromausa.com

EUROPE
CHROMA ATE EUROPE B.V.
Morsestraat 32, 6716 AH
Ede, The Netherlands
T +31-318-648282
F +31-318-648288
www.chroma.eu.com
salesnl@chroma.eu.com

CHROMA GERMANY GMBH
Südtiroler Str. 9, 86165,
Augsburg, Germany
T +49-821-790967-0
F +49-821-790967-600
www.chroma.eu.com
salesde@chroma.eu.com

JAPAN
CHROMA JAPAN
CORP.
888 Nippa-cho,
Kouhoku-ku,
Yokohama-shi,
Kanagawa,
223-0057 Japan
T +81-45-542-1118
F +81-45-542-1080
www.chroma.co.jp
info@chroma.co.jp

KOREA
CHROMA ATE
KOREA BRANCH
3F Richtogether
Center, 14,
Pangyoyeok-ro 192,
Bundang-gu,
Seongnam-si,
Gyeonggi-do
13524, Korea
T +82-31-781-1025
F +82-31-8017-6614
www.chromaate.co.kr
info@chromaate.com

CHINA
CHROMA ELECTRONICS
(SHENZHEN) CO., LTD.
8F, 4 Nanyou Tian
An Industrial Estate,
Shenzhen, China
T +86-755-2664-4598
F +86-755-2641-9620
www.chroma.com.cn
info@chromaate.com

SOUTHEAST ASIA
QUANTEL PTE LTD.
(A company of Chroma Group)
25 Kallang Avenue #05-02
Singapore 339416
T +65-6745-3200
F +65-6745-9764
www.quantel-global.com
sales@quantel-global.com